

CCTFR6311G2 CCTFR6312G2  
CCTFR6311G2D CCTFR6313G2  
CCTFR6312G2D  
CCTFR6313G2D



Wiser



Points de collecte sur [www.quefairedesdechets.fr](http://www.quefairedesdechets.fr)  
Privilégiez la réparation ou le don de votre appareil !

en Wiser HubR 2<sup>nd</sup> Generation

About this product

The Wiser HubR 2<sup>nd</sup> Generation (from herein after referenced as **HubR**) is the central control unit of the Wiser Home system. It monitors and controls the devices of your home via the Wiser Home app. The HubR can directly control a heating system and turn on a boiler.

The HubR is available in three variants, according to your heating system:

- One Channel (CCTFR6311G2, CCTFR6311G2D)  
1x heating, for combination boilers.
- Two Channels (CCTFR6312G2, CCTFR6312G2D)  
1x Heating, 1x Hot water, for conventional boilers with a separate hot water cylinder.
- Three Channels (CCTFR6313G2, CCTFR6313G2D)  
2x Heating, 1x Hot water, for large properties with dual heating circuits.

1 Package content

- A HubR 2<sup>nd</sup> Generation
- B Wall plate (mounting and wiring)
- C Installation manual

2 Operating elements

- A Setup
- B Heating
- C Hot Water (Only CCTFR6312G2, CCTFR6312G2D and CCTFR6313G2, CCTFR6313G2D)

3 Installing the wall plate

▲ ▲ DANGER

HAZARD OF ELECTRIC SHOCK, EXPLOSION, OR ARC FLASH

Safe electrical installation must be carried out only by skilled professionals. Skilled professionals must prove profound knowledge in the following areas:

- Connecting to installation networks.
- Connecting several electrical devices.
- Laying electric cables.
- Safety standards, local wiring rules and regulations.

Failure to follow these instructions will result in death or serious injury.

▲ CAUTION

EQUIPMENT DAMAGE

- The device is not fitted with a user-replaceable fuse.
- The device must be powered from a 3A Fused Spur / Circuit Breaker.

Failure to follow these instructions can result in injury or equipment damage.

a. Mounting on a flush-mounted box

b. Mounting on a flat surface

- (1) Cut the sides of the frame.
- (2) Using pliers, break off the frame piece.
- (3) Mount the wall plate to the wall.

4 Electrical connections

a. One channel (CCTFR6311G2, CCTFR6311G2D)

	Combination-Boiler
OT 1	Opentherm® connection
OT 2	Opentherm® connection

b. Two channels (CCTFR6312G2, CCTFR6312G2D)

	Hot water
	Central heating
OT 1	Opentherm® connection
OT 2	Opentherm® connection

c. Three channels (CCTFR6313G2, CCTFR6313G2D)

	Central heating circuit 1
	Hot water
	Central heating circuit 2
OT 1	Opentherm® connection
OT 2	Opentherm® connection

Refer to the system user guide for more information about the Opentherm® connection.

5 Installing the HubR

6 System User Guide

Refer to the system user guide for more information about the Wiser System. Scan the QR-Code and choose the System User Guide for your country.

Technical data

<b>Dimensions</b>	
Width:	94 mm
Height:	151 mm
Depth:	31 mm
Power supply:	230 V AC ±10% 50 Hz
Rated load:	2(1) A
Rated impulse voltage:	2.5 kV
Power consumption:	max. 6.2 W
Set point range:	5 °C to 30 °C
<b>Control accuracy</b>	
With Room Thermostat:	<0.6 °C at 4 °C per hour
With Radiator Thermostat:	<0.8 °C at 4 °C per hour
Timing resolution:	1 min
Temperature resolution:	0.5 °C
Protection class:	IP30
Ball pressure test:	75 °C
Pollution degree:	2
Software class:	A
<b>Ambient</b>	
Operating temperature:	0 °C to 45 °C
Operating humidity:	25% to 90% non condensing
Wi-Fi® standard:	IEEE 802.11 b/g/n 2.4 GHz
Wi-Fi® security:	WPA-PSK / WPA2-PSK
Maximum radio-frequency power transmitted:	50 mW
Operating frequency:	2.405 GHz - 2.48 GHz

Declaration of Conformity

Hereby, Schneider Electric Industries, declares that this product is in compliance with the essential requirements and other relevant provisions of RADIO EQUIPMENT DIRECTIVE 2014/53/EU, and The Radio Equipment Regulations SI 2017 No. 1206

Declaration of conformity can be downloaded on: [se.com/docs](http://se.com/docs)

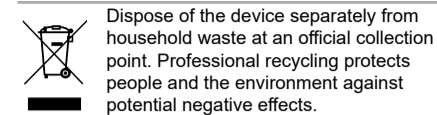

Schneider Electric Industries SAS

If you have technical questions, please contact the Customer Care Centre in your country. [se.com/contact](http://se.com/contact)

UK Representative

Schneider Electric Controls

401 Southway Drive  
Plymouth, PL6 6QT  
United Kingdom

For technical support in the UK and Ireland:  
[wiser.draytoncontrols.co.uk](http://wiser.draytoncontrols.co.uk)  
+44 (0)333 6000 622



fr Wiser Passerelle avec Relais 2<sup>e</sup> Génération

À propos de ce produit

La Wiser Passerelle avec Relais 2<sup>e</sup> Génération (désignée ci-après **HubR**) est l'unité de commande centrale du système Wiser Home. Elle surveille et commande les appareils de votre maison via l'application Wiser Home. La passerelle HubR peut directement commander un système de chauffage et envoyer une demande de chauffe à une chaudière.

Elle est disponible en trois variantes, selon votre système de chauffage :

- Monocanal (CCTFR6311G2)  
1x chauffage, pour chaudières combinées.
- Bicanal (CCTFR6312G2)  
1x chauffage, 1x eau chaude, pour chaudières conventionnelles équipées d'un ballon d'eau chaude séparé.
- Tricanal (CCTFR6313G2)  
2x chauffage, 1x eau chaude, pour les grandes propriétés disposant de circuits de chauffage doubles.

1 Contenu de l'emballage

- A Wiser Passerelle avec Relais 2e Génération
- B Plaque murale (montage et câblage)
- C Manuel d'installation

2 Éléments de commande

- A Configuration
- B Chauffage
- C Eau chaude (CCTFR6312G2 et CCTFR6313G2 uniquement)

3 Installation de la plaque murale

▲ ▲ DANGER

RISQUE DE DÉCHARGE ÉLECTRIQUE, D'EXPLOSION OU D'ARC ÉLECTRIQUE

Une installation électrique répondant aux normes de sécurité doit être réalisée uniquement par des professionnels compétents. Les professionnels compétents doivent justifier de connaissances approfondies dans les domaines suivants :

- Raccordement aux réseaux d'installation.
- Raccordement de plusieurs appareils électriques.
- Pose de câbles électriques.
- Normes de sécurité, règles et réglementations locales pour le câblage.

Le non-respect de ces instructions entraînera la mort ou des blessures graves.

▲ ATTENTION

ENDOMMAGEMENT DE L'ÉQUIPEMENT

Cet appareil n'est pas équipé d'un fusible interne. Il est recommandé de le protéger avec un disjoncteur de 3A.

Le non-respect de ces instructions peut provoquer des blessures ou des dommages matériels.

a. Montage sur une boîte d'encastrement

b. Montage en applique

- (1) Découpez les côtés du cadre.
- (2) À l'aide d'une pince, détachez la pièce de cadre.
- (3) Montez la plaque murale au mur.

4 Raccordements électriques

a. Monocanal (CCTFR6311G2)

	Chaudière combinée (Chauffage + Eau Chaude Sanitaire)
OT 1	Raccordement Opentherm®
OT 2	Raccordement Opentherm®

b. Bicanal (CCTFR6312G2)

	Eau chaude
	Chauffage central
OT 1	Raccordement Opentherm®
OT 2	Raccordement Opentherm®

c. Tricanal (CCTFR6313G2)

	Circuit de chauffage central 1
	Eau chaude
	Circuit de chauffage central 2
OT 1	Raccordement Opentherm®
OT 2	Raccordement Opentherm®

Reportez-vous au guide d'utilisation du système pour obtenir davantage d'informations sur Raccordement Opentherm®

5 Installation de la passerelle HubR

6 Guide d'utilisation du système

Reportez-vous au guide d'utilisation du système pour obtenir davantage d'informations sur le système Wiser.

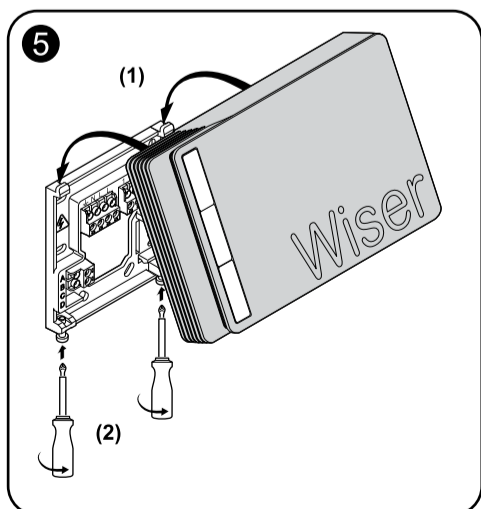
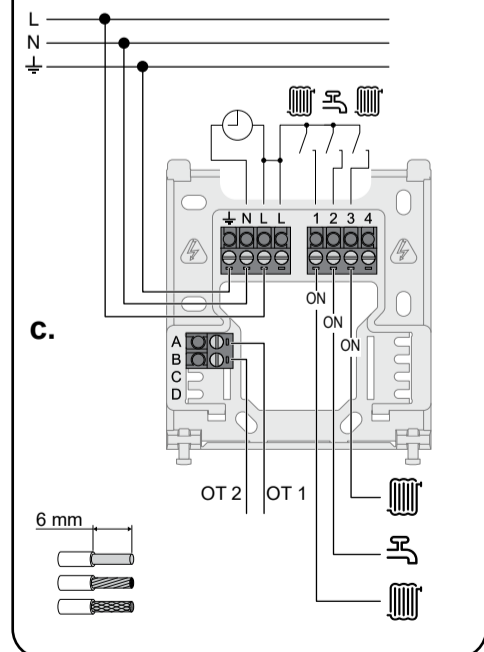
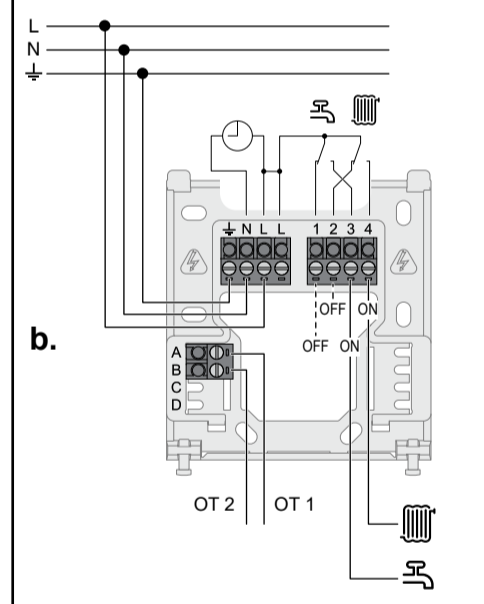
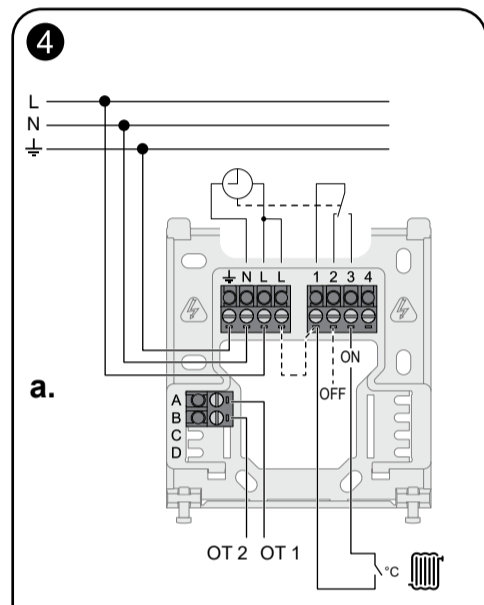
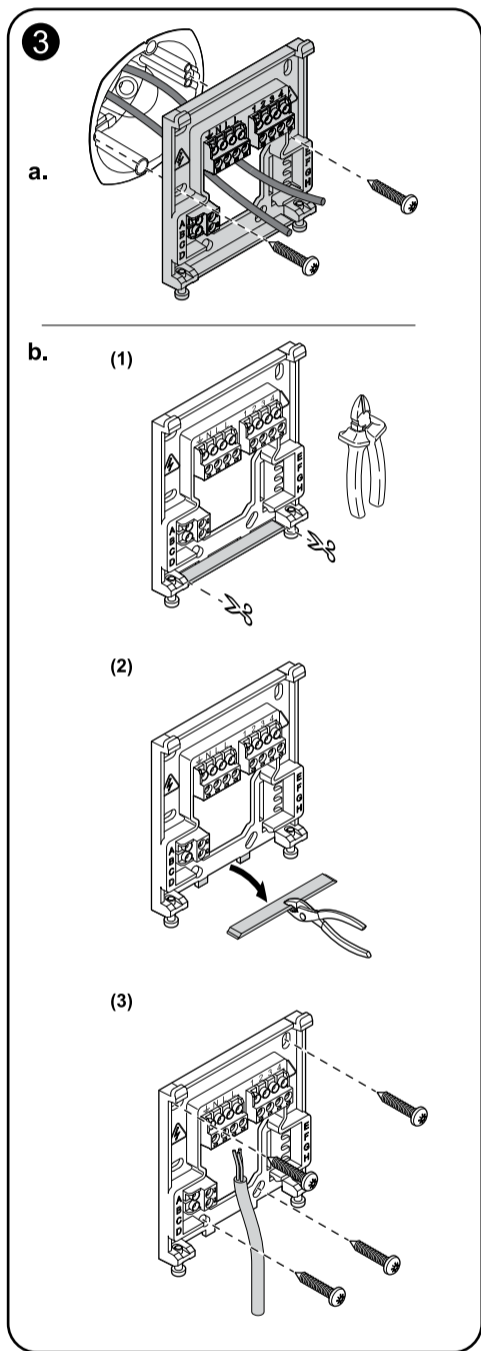
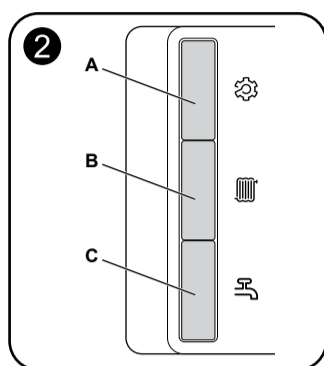
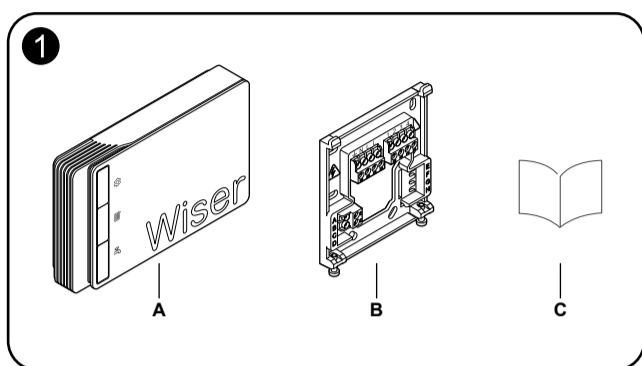

Scannez le code QR et choisissez le guide d'utilisation du système pour votre pays.

<b>Dimensions</b>	
Largeur <span> </span> :	94 mm
Hauteur <span> </span> :	151 mm
Profondeur <span> </span> :	31 mm
Alimentation <span> </span> :	230 V CA ±10 <span> </span> % 50 Hz
Charge nominale <span> </span> :	2(1) A
Tension d'impulsion nominale <span> </span> :	2,5 kV
Consommation électrique <span> </span> :	6,2 W max.
Plage de consigne <span> </span> :	de 5 <span> </span> °C à 30 <span> </span> °C
<b>Précision de commande</b>	
Avec thermostat d'ambiance <span> </span> :	< 0,6 <span> </span> °C à 4 <span> </span> °C par heure
Avec tête de vanne thermostatique <span> </span> :	< 0,8 <span> </span> °C à 4 <span> </span> °C par heure
Résolution temporelle <span> </span> :	1 min
Résolution de température <span> </span> :	0,5 <span> </span> °C
Indice de protection	IP30
Test de pression à bille <span> </span> :	75 <span> </span> °C
Niveau de pollution <span> </span> :	2
Classe de logiciel <span> </span> :	A
<b>Conditions ambiantes</b>	
Température de fonctionnement <span> </span> :	0 <span> </span> °C à 45 <span> </span> °C
Humidité de fonctionnement	25 à 90 <span> </span> % sans condensation
Norme WiFi® <span> </span> :	IEEE 802.11 b/g/n 2,4 GHz
Sécurité WiFi® <span> </span> :	WPA-PSK/WPA2-PSK
Puissance de radiofréquence maximale transmise <span> </span> :	50 mW
Fréquence de fonctionnement <span> </span> :	2,405 GHz-2,48 GHz

## Déclaration de conformité

Schneider Electric Industries déclare par la présente que ce produit est conforme aux exigences essentielles et aux autres dispositions pertinentes de la DIRECTIVE 2014/53/UE sur les ÉQUIPEMENTS RADIOÉLECTRIQUES et du règlement sur les équipements radioélectriques SI n° 1206 de 2017.

La déclaration de conformité peut être téléchargée à l'adresse suivante : [se.com/docs](http://se.com/docs).

	Ne jetez pas l'appareil avec les déchets ménagers, mais déposez-le dans un centre de collecte officiel. Un recyclage professionnel protège les personnes et l'environnement contre d'éventuels effets négatifs.
--	---

### Schneider Electric Industries SAS

Si vous avez des questions d'ordre technique, veuillez contacter le service client de votre pays.

[se.com/contact](http://se.com/contact)

## de Wiser Hub mit Relais (2. Generation)

### Über dieses Produkt

Der Wiser Hub mit Relais (2. Generation), nachstehend als **HubR** bezeichnet, ist das zentrale Steuermodul des Wiser Home Systems. Von hier aus werden Ihre Geräte über die Wiser Home App gesteuert. Über den HubR kann eine Heizungsanlage direkt angesteuert und ein Heizkessel eingeschaltet werden.

Der HubR ist je nach Heizungsanlage in drei Ausführungen erhältlich:

- Ein Kanal (CCTFR6311G2)
  - 1 x Heizung, für Kombikessel.
- Zwei Kanäle (CCTFR6312G2)
  - 1 x Heizung, 1 x Warmwasser, für konventionelle Heizkessel mit separatem Warmwasserzylinder.
- Drei Kanäle (CCTFR6313G2)
  - 2 x Heizung, 1 x Warmwasser, für große Anwesen mit dualen Heizkreisen.

### 1 Inhalt des Pakets

- A** Wiser Hub mit Relais (2. Generation)
- B** Wandplatte (Montage und Verkabelung)
- C** Installationsanleitung

### 2 Bedienelemente

- A** Einrichtung
- B** Heizung
- C** Warmwasser (nur CCTFR6312G2 und CCTFR6313G2)

### 3 Montage der Wandplatte

<b><span>▲ ▲</span> GEFAHR</b>
<b>GEFAHR VON ELEKTRISCHEM SCHLAG, EXPLOSION ODER LICHTBOGEN</b>
Die sichere Elektroinstallation darf ausschließlich von entsprechend geschultem Fachpersonal durchgeführt werden. Das hierfür eingesetzte Fachpersonal muss über umfangreiches Fachwissen in den folgenden Bereichen verfügen: <ul style="list-style-type: none"><li>Anschluss an Installationsnetze</li> <li>Verbindung mehrerer elektrischer Geräte</li> <li>Verlegung von Elektroleitungen</li> <li>Sicherheitsstandards, vor Ort geltende Regeln und Verordnungen zur Verlegung von Kabeln.</li></ul> <b>Die Nichtbeachtung dieser Anweisungen hat Tod oder schwere Verletzungen zur Folge.</b>

<b><span>▲</span> VORSICHT</b>
<b>BESCHÄDIGUNG DES GERÄTES</b>
Das Gerät ist nicht mit einer vom Benutzer austauschbaren Sicherung ausgestattet. <ul style="list-style-type: none"><li>Das Gerät muss über einen abgesicherten Stromkreis / Leistungsschutzschalter mit 3 A versorgt werden.</li></ul> <b>Die Nichtbeachtung dieser Anweisungen kann Verletzungen oder Sachschäden zur Folge haben.</b>

- Montage an einer Unterputzdose
- Montage auf einer ebenen Fläche
  - Die Seiten des Rahmens abtrennen.
  - Das Rahmenteil mit einer Zange abbrechen.
  - Die Wandplatte an der Wand befestigen.

### 4 Elektrische Anschlüsse

- Ein Kanal (CCTFR6311G2)



	Kombikessel
OT 1	Opentherm®-Anschluss

OT 2	Opentherm®-Anschluss
------	----------------------

- Zwei Kanäle (CCTFR6312G2)

	Warmwasser
	Zentralheizung
OT 1	Opentherm®-Anschluss
OT 2	Opentherm®-Anschluss

- Drei Kanäle (CCTFR6313G2)

	Zentralheizkreis 1
	Warmwasser
	Zentralheizkreis 2
OT 1	Opentherm®-Anschluss
OT 2	Opentherm®-Anschluss

Weitere Opentherm®-Anschluss Informationen finden Sie im Benutzerhandbuch.

### 5 Montage des HubR

### 6 System-Benutzerhandbuch

Weitere Informationen finden Sie im Wiser System-Benutzerhandbuch. Scannen Sie den QR-Code, und wählen Sie das System-Benutzerhandbuch für Ihr Land aus.

<b>Abmessungen</b>	
Breite:	94 mm
Höhe:	151 mm
Tiefe:	31 mm
Stromversorgung:	230 V AC ±10 <span> </span> % 50 Hz
Solllast:	2(1) A
Bemessungsstoßspannung:	2,5 kV
Stromverbrauch:	max. 6.2 W
Sollwertbereich:	5 bis 30 <span> </span> °C
<b>Regelgenauigkeit</b>	
Mit Raumthermostat:	< 0,6 <span> </span> °C bei 4 <span> </span> °C pro Stunde
Mit Heizkörperthermostat:	< 0,8 <span> </span> °C bei 4 <span> </span> °C pro Stunde
Zeitauflösung:	1 min
Temperaturauflösung:	0,5 <span> </span> °C
Schutzklasse	IP30
Kugeldrucktest:	75 <span> </span> °C
Verschmutzungsgrad:	2
Softwareklasse:	A
<b>Umgebung</b>	
Betriebstemperatur:	0 bis 45 <span> </span> °C
Feuchtigkeit	25 bis 90 <span> </span> %, nicht kondensierend
Wi-Fi®-Norm:	IEEE 802.11 b/g/n 2,4 GHz
Wi-Fi®-Sicherheit:	WPA-PSK / WPA2-PSK
Max. übertragene Funkfrequenzleistung:	50 mW
Betriebsfrequenz:	2,405 - 2,48 GHz

### Konformitätserklärung

Schneider Electric Industries erklärt hiermit, dass dieses Produkt die grundlegenden Anforderungen und anderen relevanten Bestimmungen der FUNKANLAGEN-RICHTLINIE 2014/53/EU sowie der UK-Funkanlagen-Richtlinie SI 2017 Nr. 1206 erfüllt.

Die Konformitätserklärung kann heruntergeladen werden unter: [se.com/docs](http://se.com/docs).

	Entsorgen Sie das Gerät getrennt vom Hausmüll bei einer offiziellen Sammelstelle. Fachgerechtes Recycling schützt Mensch und Umwelt vor möglichen negativen Auswirkungen.
---	---

### Schneider Electric Industries SAS

Bei technischen Fragen wenden Sie sich bitte an das Customer Care Center in Ihrem Land.

[se.com/contact](http://se.com/contact)

## es HubR Wiser 2.ª Generación

### Acerca de este producto

El HubR Wiser 2.ª Generación (en lo sucesivo, **HubR**) es la unidad de control central del sistema Wiser Home. Supervisa y controla los dispositivos de su vivienda a través de las aplicaciones Wiser Home. El HubR puede controlar directamente un sistema de calefacción y encender una caldera.

El HubR está disponible en tres variantes en función de su sistema de calefacción:

- Monocanal (CCTFR6311G2)
  - 1x calefacción, para calderas combinadas.
- Dos canales (CCTFR6312G2)
  - 1x calefacción, 1x agua caliente, para calderas convencionales con un cilindro de agua caliente separado.
- Tres canales (CCTFR6313G2)
  - 2x calefacción y 1x agua caliente, para grandes propiedades con circuitos de calefacción dobles.

### 1 Contenido del paquete

- A** HubR Wiser 2.ª Generación
- B** Placa de pared (montaje y cableado)
- C** Manual de instalación

### 2 Elementos de mando

- A** Configuración
- B** Calefacción
- C** Agua caliente (solo CCTFR6312G2 y CCTFR6313G2)

### 3 Instalación de la placa de pared

<b><span>▲ ▲</span> PELIGRO</b>
<b>PELIGRO DE DESCARGA ELÉCTRICA, EXPLOSIÓN O ARCO ELÉCTRICO</b>
La instalación eléctrica solo debe ser realizada por profesionales cualificados de forma segura. Los profesionales capacitados deben demostrar un amplio conocimiento en las siguientes áreas: <ul style="list-style-type: none"><li>Conexión a redes de instalación.</li> <li>Conexión de varios dispositivos eléctricos.</li> <li>Tendido de cables eléctricos.</li> <li>Normas de seguridad, normativas y reglamentos locales sobre cableado.</li></ul> <b>Si no se siguen estas instrucciones, podrían producirse lesiones graves o incluso la muerte.</b>

<b><span>▲</span> PRECAUCIÓN</b>
<b>DAÑOS EN EL EQUIPO</b>
El dispositivo no está equipado con un fusible reemplazable por el usuario final. <ul style="list-style-type: none"><li>El dispositivo debe estar alimentado a través de una protección eléctrica o un fusible de 3A.</li></ul> <b>El incumplimiento de estas instrucciones puede ocasionar lesiones o desperfectos en el equipo.</b>

- Montaje en una caja empotrada
- Montaje sobre una superficie plana
  - Corte los laterales del marco.
  - Con unos alicates, rompa la pieza del marco.
  - Monte la placa de pared a la pared.

### 4 Conexiones eléctricas



- Monocanal (CCTFR6311G2)

	Combinación de caldera
OT 1	Conexión de Opentherm®
OT 2	Conexión de Opentherm®

- Dos canales (CCTFR6312G2)

	Agua caliente
	Calefacción central
OT 1	Conexión de Opentherm®
OT 2	Conexión de Opentherm®

- Tres canales (CCTFR6313G2)

	Calefacción central circuito 1
	Agua caliente
	Calefacción central circuito 2
OT 1	Conexión de Opentherm®
OT 2	Conexión de Opentherm®

Consulte la guía del usuario del sistema para obtener más información acerca Conexión de Opentherm®.

### 5 Instalación del HubR

### 6 Guía del usuario del sistema

Consulte la guía del usuario del sistema para obtener más información acerca del sistema Wiser. Escanee el código QR y seleccione la guía de usuario del sistema de su país.

<b>Dimensiones</b>	
Ancho:	94 mm
Altura:	151 mm
Profundidad:	31 mm
Tensión de alimentación:	230 V CA ±10 <span> </span> % 50 Hz
Carga nominal:	2(1) A
Sobretensión de choque nominal:	2,5 kV
Consumo de potencia:	máx. 6,2 W
Rango del valor de referencia:	de 5 <span> </span> °C a 30 <span> </span> °C
<b>Precisión de control</b>	
Con termostato de habitación:	<0,6 <span> </span> °C a 4 <span> </span> °C por hora
Con termostato del radiador:	<0,8 <span> </span> °C a 4 <span> </span> °C por hora
Resolución temporal:	1 min
Resolución de la temperatura:	0,5 <span> </span> °C
Clase de protección	IP30
Prueba de presión de bola:	75 <span> </span> °C
Grado de contaminación:	2
Clase de software:	A
<b>Ambiente</b>	
Temperatura de funcionamiento:	De 0 a 45 <span> </span> °C
Humedad de funcionamiento	Del 25 <span> </span> % al 90 <span> </span> %, sin condensación
Wi-Fi® estándar:	IEEE 802.11 b/g/n 2,4 GHz
Seguridad Wi-Fi®:	WPA-PSK/WPA2-PSK
Potencia de radiofrecuencia máx. transmitida:	50mW
Frecuencia de funcionamiento:	2,405 GHz - 2,48 GHz

### Declaración de conformidad

Por la presente, Schneider Electric Industries, declara que este producto cumple con los requisitos esenciales y otras disposiciones pertinentes de la DIRECTIVA DE EQUIPOS DE RADIO 2014/53/UE y los Reglamentos sobre equipos radioeléctricos SI 2017 n.º 1206

La declaración de conformidad se puede descargar en: [se.com/docs](http://se.com/docs).

	Elimine el dispositivo separado de la basura doméstica en los puntos de recogida oficiales. El reciclado profesional protege a las personas y al medio ambiente de posibles efectos negativos.
---	--

### Schneider Electric Industries SAS

Si tiene alguna duda técnica, póngase en contacto con el servicio de atención al cliente de su país.

[se.com/contact](http://se.com/contact)

## pt Hubr Wiser 2ª Geração

### Acerca deste produto

O Hubr Wiser 2ª Geração (a seguir designado **HubR**) é a unidade de controlo central do sistema Wiser Home. Monitoriza e controla os dispositivos da sua casa através da aplicação Wiser Home. O HubR pode controlar diretamente um sistema de aquecimento e ligar uma caldeira. O HubR está disponível em três variantes, de acordo com o seu sistema de aquecimento:

- Um canal (CCTFR6311G2)
  - 1x aquecimento, para a combinação de várias caldeiras.
- Dois canais (CCTFR6312G2)
  - 1x Aquecimento, 1x Água quente, para caldeiras convencionais com um cilindro de água quente separado.
- Três canais (CCTFR6313G2)
  - 2x Aquecimento, 1x Água quente, para propriedades grandes com circuitos de aquecimento duplos.

### 1 Conteúdo da embalagem

- A** Hubr Wiser 2ª Geração
- B** Placa de parede (montagem e ligação elétrica)
- C** Manual de instalação

### 2 Elementos de operação

- A** Configuração
- B** Aquecimento
- C** Água Quente (apenas CCTFR6312G2 e CCTFR6313G2)

### 3 Instalar a placa de parede

<b><span>▲ ▲</span> PERIGO</b>
<b>PERIGO DE CHOQUE ELÉTRICO, EXPLOÃO OU ARCO ELÉTRICO</b>
A instalação elétrica segura deve ser realizada unicamente por profissionais qualificados. Os profissionais qualificados devem deter conhecimentos profundos nas seguintes áreas: <ul style="list-style-type: none"><li>Ligação a redes de instalação.</li> <li>Ligação de vários dispositivos elétricos.</li> <li>Instalação de cabos elétricos.</li> <li>Normas de segurança e regras e regulamentos locais de instalações elétricas.</li></ul> <b>O incumprimento destas instruções tem como conseqüências a morte ou ferimentos graves.</b>

<b><span>▲</span> CUIDADO</b>
<b>DANOS NO EQUIPAMENTO</b>
O dispositivo não está equipado com um fusível substituível pelo usuário final. <ul style="list-style-type: none"><li>O dispositivo deve estar alimentado através de uma proteção elétrica ou fusível de 3A</li></ul> <b>O incumprimento destas instruções pode causar ferimentos ou danos no equipamento.</b>

- Montar numa caixa de montagem embutida.
- Montar numa superfície plana.
  - Cortar os lados do espelho.
  - Com a ajuda de uma alicate, parta a peça do espelho.
  - Monte a placa de parede na parede.

### 4 Ligações elétricas



- Um canal (CCTFR6311G2)

	Combinação-Caldeira
OT 1	Conexão Opentherm®
OT 2	Conexão Opentherm®

- Dois canais (CCTFR6312G2)

	Água quente
	Aquecimento central
OT 1	Conexão Opentherm®
OT 2	Conexão Opentherm®

- Três canais (CCTFR6313G2)

	Circuito de aquecimento central 1
	Água quente
	Circuito de aquecimento central 2
OT 1	Conexão Opentherm®
OT 2	Conexão Opentherm®

Consulte o manual do utilizador do sistema para obter mais informações sobre o Conexão Opentherm®.

### 5 Instalar o HubR

### 6 Manual do Utilizador do Sistema

Consulte o manual do utilizador do sistema para obter mais informações sobre o sistema Wiser. Digitalize o código QR e escolha o Manual do Utilizador do Sistema para o seu país.

<b>Dimensões</b>	
Largura:	94 mm
Altura:	151 mm
Profundidade:	31 mm
Fonte de alimentação:	230 V CA ±10% 50 Hz
Carga nominal:	2(1) A
Tensão nominal de impulso:	2,5 kV
Consumo de energia:	máx. 6,2 W
Definir o ponto de referência:	5 <span> </span> °C a 30 <span> </span> °C
<b>Precisão de controlo</b>	
Com termóstato da divisão:	< 0,6 <span> </span> °C a 4 <span> </span> °C por hora
Com termóstato Radiador Wiser:	< 0,8 <span> </span> °C a 4 <span> </span> °C por hora
Resolução temporal:	1 min
Resolução de temperatura:	0,5 <span> </span> °C
Classe de proteção	IP 30
Teste de pressão de esfera:	75 <span> </span> °C
Grau de poluição:	2
Classe de software:	A
<b>Ambiente</b>	
Temperatura de funcionamento:	0 <span> </span> °C a 45 <span> </span> °C
Humidade de funcionamento	25% a 90% sem condensação
Norma de Wi-Fi® <span> </span> :	IEEE 802.11 b/g/n 2,4 GHz
Segurança de Wi-Fi® <span> </span> :	WPA-PSK / WPA2-PSK
Potência máx. de radiofrequência transmitida:	50 mW
Frequência de operação:	2,405 GHz - 2,48 GHz

### Declaração de conformidade

A Schneider Electric Industries declara por este meio que o presente produto cumpre os requisitos fundamentais e outras disposições relevantes da DIRETIVA 2014/53/UE RELATIVA A EQUIPAMENTOS DE RÁDIO e os regulamentos de Equipamento de Rádio SI 2017 n.º 1206

A Declaração de Conformidade encontra-se disponível para ser transferida em: [se.com/docs](http://se.com/docs).

transferida em: [se.com/docs](http://se.com/docs).

	Separar o dispositivo do restante lixo doméstico colocando-o num ponto de recolha oficial. A reciclagem profissional protege o ambiente e as pessoas de possíveis efeitos prejudiciais.
---	---

### Schneider Electric Industries SAS

Para perguntas técnicas, queira contactar o Centro de Atendimento ao Cliente do seu país.

[se.com/contact](http://se.com/contact)

### Trademarks

- Wiser™ is a trademark and the property of Schneider Electric SE, its subsidiaries and affiliated companies.
- Wi-Fi® is a registered trademark of Wi-Fi Alliance®.
- Apple® and App Store® are brand names or registered trademarks of Apple Inc.
- Google Play™ Store and Android™ are brand names or registered trademarks of Google Inc.

Other brands and registered trademarks are properties of their relevant owners.

