

Thank you for choosing HE200 series high-performance AC Drive.



The diagrams in this operating instruction are for the convenience of description, and may be slightly different from the product. Due to product upgrades, it may also be slightly different. Please refer to the actual product.

Please pay attention to hand this practical manual to the end user, and keep it properly for future inspection and maintenance.

If you have any questions, please contact our company or our agent in time, we will serve you wholeheartedly.

Chapter 1 Selection

Nameplate description

ZHENYUAN		
MODEL	HE200-T3-3R7G	
POWER	3.7KW	
INPUT	AC 380/400V	
OUTPUT	9A	
SER. NO NUMBER	 20200907118	

Shenzhen Zhenyuan Electric Co., Ltd

Model: HE200-T3-3R7G

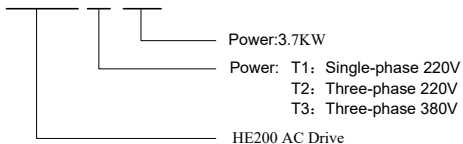

Chapter 2 Dimensions

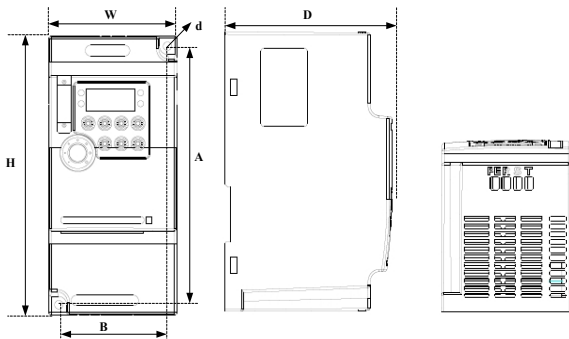

Note: Support standard 35mm rail installation (under 5.5KW)

unit : mm

Model	W	H	D	A	B	d
HE200-T3-0R7G--HE200-T3-2R2G	72	142	112.2	130	61	4.5
HE200-T3-3R7G--HE200-T3-5R5G	85	180	116	167	72	5.5
HE200-T3-7R5G--HE200-T3-011G	106	240	153	230	96	4.5
HE200-T3-015G--HE200-T3-022G	151	332	165.5	318	137	7

Chapter 3 Wiring

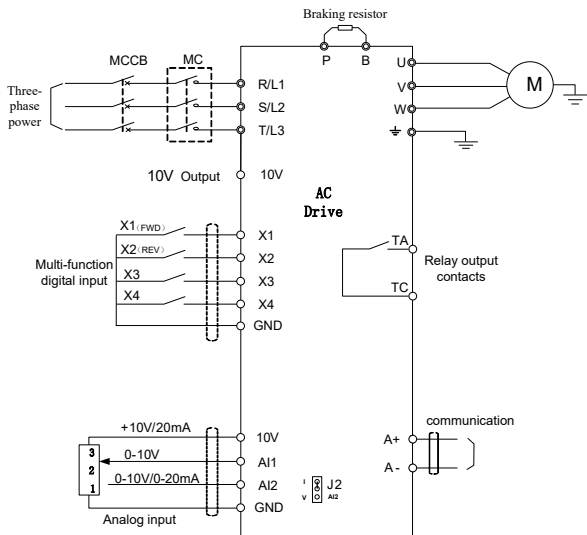

HE200 AC Drive Standard Diagram

The main circuit terminal arrangement of HE200 AC Drive is shown in the figure below :

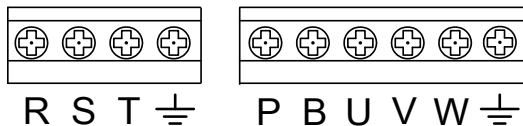

- Three-phase AC power input terminal : R、S、T
- Ground connection \perp terminal : PE
- Connection terminals of energy-consumption braking resistor : P、B
- Motor terminal : U、V、W

The terminal arrangement of HE200 AC Drive control circuit is shown in the figure below:

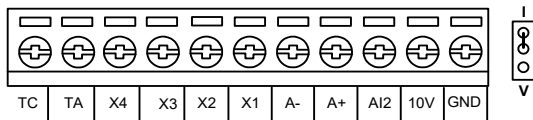

Control circuit terminal

- Analog input terminal : AI2。
- Switch input terminal : X1、X2、X3、X4。
- Relay output terminal : TA-TC。
- Auxiliary power terminal : +10V、GND。
- RS485 communication terminal : A+ , A-。

Chapter 4 Function Code Table

Group P and Group A are standard function parameters. Group D includes the monitoring function parameters.

The symbols in the function code table are described as follows:

“●” : The parameter can be modified when the AC drive is in either stop or running state.

“○” : The parameter cannot be modified when the AC drive is in the running state.

“x” : The parameter is the actually measured value and cannot be modified.

Standard Function Parameters

Function Code	Parameter Name	Setting Range	Default	Property
P0 : Standard Function Parameters				
P0.01	Motor 1 control mode	0: Voltage/Frequency (V/F) control 1: Sensorless flux vector control	0	○
P0.02	Command source selection	0: Operation panel control 1: Terminal control 2: Communication control	0	●
P0.03	Main frequency source A selection	0: Digital setting (non-retentive at power failure) 1: Digital setting (retentive at power failure) 2: panel Potentiometer (AI1) 3: AI2 4: External panel 5: reserve 6: Multi-reference 7: Simple PLC 8: PID 9: Communication setting	0	○
P0.04	Auxiliary frequency source B selection	The same as P0.03	0	○
P0.05	Range of auxiliary frequency B	0: Relative to maximum frequency 1: Relative to main frequency X	0	●

Function Code	Parameter Name	Setting Range	Default	Property
P0.06	Range of auxiliary frequency B	0%~150%	100%	●
P0.07	Frequency source selection	Unit's digit (Frequency source selection) 0: Main frequency source X 1: X and Y operation (operation relationship determined by ten's digit) 2: Switchover between X and Y 3: Switchover between X and "X and Y operation" 4: Switchover between Y and "X and Y operation" Ten's digit (X and Y operation relationship) 0: X+Y 1: X-Y 2: Maximum 3: Minimum	00	●
P0.08	Preset frequency	0.00Hz~maximum frequency (P0.10)	50.00Hz	●
P0.09	Rotation direction	0: Same direction 1: Reverse direction	0	●
P0.10	Maximum frequency	50.00Hz~600.00Hz	50.00Hz	○
P0.11	Source of frequency upper limit	0: Set by P0.12 1: AI1 2: AI2 3: reserve 4: reserve 5: Communication setting	0	○
P0.12	Frequency upper limit	Frequency lower limit (P0.14) to maximum frequency (P0.10)	50.00Hz	●
P0.13	Frequency upper limit offset	0.00 Hz to maximum frequency (P0.10)	0.00Hz	●
P0.14	Frequency lower limit	0.00 Hz to frequency upper limit (P0.12)	0.00Hz	●
P0.15	Carrier frequency	0.5kHz~16.0kHz	机型确定	●
P0.16	Carrier frequency adjustment with temperature	0: No 1: Yes	1	●
P0.17	Acceleration time 1	0.00s~65000s	机型确定	●
P0.18	Deceleration time 1	0.00s~65000s	机型确定	●

Function Code	Parameter Name	Setting Range	Default	Property
P0.19	Acceleration/Deceleration time unit	0: 1s 1: 0.1s 2: 0.01s	1	○
P0.21	Frequency offset of auxiliary frequency source for A and B operation	0.00 Hz to maximum frequency (P0.10)	0.00Hz	●
P0.22	Frequency reference resolution	1: 0.1Hz 2: 0.01Hz	2	○
P0.23	Retentive of digital setting frequency upon power failure	0: Not retentive 1: Retentive	0	●
P0.24	Motor parameter group selection	0: Motor parameter group 1 1: Motor parameter group 2	0	○
P0.25	Acceleration/Deceleration time base frequency	0: Maximum frequency (P0.10) 1: Set frequency 2: 100 Hz	0	○
P0.26	Base frequency for UP/DOWN modification during running	0: Running frequency 1: Set frequency	0	○
P0.27	Binding command source to frequency source	Unit's digit (Binding operation panel command to frequency source) 0: No binding 1: Frequency source by digital setting 2: AI1 3: AI2 4: reserve 5: reserve 6: Multi-reference 7: Simple PLC 8: PID 9: Communication setting Ten's digit (Binding terminal command to frequency source) Hundred's digit (Binding communication command to frequency source)	0000	●

Function Code	Parameter Name	Setting Range	Default	Property
P1 : Motor 1 Parameters				
P1.00	Motor type selection	0: Common asynchronous motor 1: Variable frequency asynchronous motor	0	<input type="radio"/>
P1.01	Rated motor power	0.1kW~1000.0kW	Model dependent	<input type="radio"/>
P1.02	Rated motor voltage	1V~2000V	Model dependent	<input type="radio"/>
P1.03	Rated motor current	0.01~655.35 A (AC drive power ≤ 55 kW) 0.1~6553.5 A (AC drive power > 55 kW)	Model dependent	<input type="radio"/>
P1.04	Rated motor frequency	0.01 Hz to maximum frequency	Model dependent	<input type="radio"/>
P1.05	Rated motor rotational	1rpm~65535rpm	Model dependent	<input type="radio"/>
P1.06	Stator resistance (asynchronous motor)	0.001~65.535 Ω (AC drive power ≤ 55 kW) 0.0001~6.5535 Ω (AC drive power > 55 kW)	Model dependent	<input type="radio"/>
P1.07	Rotor resistance (asynchronous motor)	0.001~65.535 Ω (AC drive power ≤ 55 kW) 0.0001~6.5535 Ω (AC drive power > 55 kW)	Model dependent	<input type="radio"/>
P1.08	Leakage inductive reactance (asynchronous motor)	0.01~655.35 mH (AC drive power ≤ 55 kW) 0.001~65.535 mH (AC drive power > 55 kW)	Model dependent	<input type="radio"/>
P1.09	Mutual inductive reactance (asynchronous motor)	0.1~6553.5 mH (AC drive power ≤ 55 kW) 0.01~655.35 mH (AC drive power > 55 kW)	Model dependent	<input type="radio"/>
P1.10	No-load current (asynchronous motor)	0.01 to F1-03 (AC drive power ≤ 55 kW) 0.1 to F1-03 (AC drive power > 55 kW)	Model dependent	<input type="radio"/>
P1.37	Auto-tuning selection	0: No auto-tuning 1: Asynchronous motor static auto-tuning 2: Asynchronous motor complete auto-tuning	0	<input type="radio"/>

Function Code	Parameter Name	Setting Range	Default	Property
P2 : Vector Control Parameters				
P2.00	Speed loop proportional gain 1	1~100	30	●
P2.01	Speed loop integral time 1	0.01s~10.00s	0.50s	●
P2.02	Switchover frequency 1	0.00~P2.05	5.00Hz	●
P2.03	Speed loop proportional gain 2	1~100	20	●
P2.04	Speed loop integral time 2	0.01s~10.00s	1.00s	●
P2.05	Switchover frequency 2	P2.02~maximum output frequency	10.00Hz	●
P2.06	Vector control slip gain	50%~200%	100%	●
P2.07	Time constant of speed loop filter	0.000s~1.000s	0.050s	●
P2.09	Torque upper limit source in speed control mode	0: P2.10 1: AI1 2: AI2 3: AI3 4: Pulse setting (X5) 5: Communication setting	0	●
P2.10	Digital setting of torque upper limit in speed control mode	0.0%~200.0%	150.0%	●
P2.13	Excitation adjustment proportional gain	0~60000	2000	●
P2.14	Excitation adjustment integral gain	0~60000	1300	●
P2.15	Torque adjustment proportional gain	0~60000	2000	●
P2.16	Torque adjustment integral gain	0~60000	1300	●
P2.17	Speed loop integral property	Unit's digit: integral separation 0: Disabled 1: Enabled	0	●

Function Code	Parameter Name	Setting Range	Default	Property
P2.20	Maximum modulation ratio	100%~110%	105%	○
P2.21	Maximum torque coefficient of field weakening	50%~200%	100%	●
P3 : V/F Control Parameters				
P3.00	V/F curve setting	0: Linear V/F 1: Multi-point V/F 2: Square V/F 3: 1.2-power V/F 4: 1.4-power V/F 6: 1.6-power V/F 8: 1.8-power V/F 9: Reserved	0	○
P3.01	Torque boost	0.0% (fixed torque boost) 0.1%~30.0%	Model dependent	●
P3.02	Cut-off frequency of torque boost	0.00 Hz to maximum output frequency	50.00Hz	○
P3.03	Multi-point V/F frequency 1(F1)	0.00Hz to P3.05	0.00Hz	○
P3.04	Multi-point V/F voltage 1(V1)	0.0%~100.0%	0.0%	○
P3.05	Multi-point V/F frequency 2(F2)	P3.03 to P3.07	0.00Hz	○
P3.06	Multi-point V/F voltage 2	0.0%~100.0%	0.0%	○
P3.07	Multi-point V/F frequency 3(F3)	P3.05 to rated motor frequency (P1.04)	0.00Hz	○
P3.08	Multi-point V/F frequency 3(F3)	0.0%~100.0%	0.0%	○
P3.09	Multi-point V/F voltage 3(V3)	0.0%~200.0%	0.0%	●
P3.10	V/F over-excitation gain	0~200	64	●
P3.11	V/F oscillation suppression	0~100	Model dependent	●

Function Code	Parameter Name	Setting Range	Default	Property
P3.13	Voltage source for V/F separation	0: Digital setting (P3.14) 1: AI1 2: AI2 3: reserve 4: reserve 5: Multi-reference 6: Simple PLC 7: PID 8: Communication setting 100.0% corresponds to the rated motor voltage	0	●
P3.14	Voltage digital setting for V/F	0 V to rated motor voltage	0V	●
P3.15	Voltage rise time of V/F separation	0.0~1000.0s It indicates the time for the voltage rising from 0 V to rated motor voltage.	0.0s	●
P3.16	Voltage decline time of V/F separation	0.0~1000.0s It indicates the time for the voltage to decline from rated motor voltage to 0 V.	0.0s	●
P3.17	Stop mode selection upon V/F separation	0: Frequency and voltage declining to 0 independently 1: Frequency declining after	0	●
P3.18	Current limit level	50%~200%	150%	●
P3.19	Current limit control	0: Disable 1: Enable	1	○
P3.20	Current limit gain	0~100	20	●
P3.21	Current limit compensation gain	50%~200%	50%	○
P3.22	Overvoltage stall protective	200.0V~2000.0V	700V	○
P3.23	Overvoltage stall control	0: Disable 1: Enable	1	○
P3.24	Overvoltage stall Gain 1	0~100	30	●
P3.25	Overvoltage stall Gain 2	0~100	30	●
P3.26	Overvoltage stall Max frequency	0~100Hz	5Hz	○
P3.27	Slip time compensation	0.1~10.0	0	●

Function Code	Parameter Name	Setting Range	Default	Property
P4 : Input Terminals				
P4.00	X1 function selection	0: No function 1: Forward RUN (FWD) 2: Reverse RUN (REV) 3: Three-line control 4: Forward JOG (FJOG) 5: Reverse JOG (RJOG) 6: Terminal UP 7: Terminal DOWN 8: Coast to stop 9: Fault reset (RESET) 10: RUN pause 11: Normally open (NO) input of external fault 12: Multi-reference terminal 1 13: Multi-reference terminal 2 14: Multi-reference terminal 3 15: Multi-reference terminal 4 16: Terminal 1 for acceleration/ deceleration time selection 17: Terminal 2 for acceleration/ deceleration time selection 18: Frequency source switchover 19: UP and DOWN setting clear (terminal, operation panel) 20: Command source switchover terminal 1 21: Acceleration/Deceleration Prohibited 22: PID pause 23: PLC status reset 24: Swing pause 25: Counter input 26: Counter reset 27: Length count input 28: Length reset 29: Torque control prohibited 30: Reserved 31:Reserved 32: Immediate DC braking 33: Normally closed (NC) input of external fault 34: Frequency modification Forbidden 35: Reverse PID action direction 36: External STOP terminal 1	1	○
P4.01	X2 function selection		2	○
P4.02	X3 function selection		9	○
P4.03	X4 function selection		12	○
P4.04	reserve		13	○
P4.05	reserve		0	○
P4.06	reserve		0	○
P4.07	reserve		0	○
P4.08	reserve		0	○

Function Code	Parameter Name	Setting Range	Default	Property
P4.09	reserve	37: Command source switchover terminal 2 38: PID integral pause 39: Switchover between main frequency source X and preset frequency 40: Switchover between auxiliary frequency source Y and preset frequency 41: Motor selection terminal 1 42: Motor selection terminal 2 43: PID parameter switchover 44: User-defined fault 1 45: User-defined fault 2 46: Speed control/Torque control switchover 47: Emergency stop 48: External STOP terminal 2 49: Deceleration DC braking 50: Clear the current running time 51: Switchover between two-line mode and three-line mode 52-59: Reserved	0	○
P4.10	X filter time	0.000s~1.000s	0.010s	●
P4.11	Terminal command mode	0: Two-line mode 1 1: Two-line mode 2 2: Three-line mode 1 3: Three-line mode 2	0	○
P4.12	Terminal UP/DOWN rate	0.001Hz/s~65.535Hz/s	1.00Hz/s	●
P4.13	AI curve 1 minimum input	0.00V~P4.15	0.00V	●
P4.14	Corresponding setting of AI curve 1 minimum input	-100.0%~+100.0%	0.0%	●
P4.15	AI curve 1 maximum input	P4.13~+10.00V	10.00V	●
P4.16	Corresponding setting of AI curve 1 maximum input	-100.0%~+100.0%	100.0%	●
P4.17	AI curve 1 filter time	0.00s~10.00s	0.10s	●

Function Code	Parameter Name	Setting Range	Default	Property
P4.18	AI curve 2 minimum input	0.00V~P4.20	0.00V	●
P4.19	Corresponding setting of AI curve 2 minimum	-100.0%~+100.0%	0.0%	●
P4.20	AI curve 2 maximum input	P4.18~+10.00V	10.00V	●
P4.21	Corresponding setting of AI curve 2 maximum input	-100.0%~+100.0%	100.0%	●
P4.22	AI curve 2 filter time	0.00s~10.00s	0.10s	●
P4.23	AI curve 3 minimum input	-10.00V~P4.25	-10.00V	●
P4.24	Corresponding setting of AI curve 3 minimum input	-100.0%~+100.0%	-100.0%	●
P4.25	AI curve 3 maximum input	P4.23~+10.00V	10.00V	●
P4.26	Corresponding setting of AI curve 3 maximum input	-100.0%~+100.0%	100.0%	●
P4.27	AI curve 3 filter time	0.00s~10.00s	0.10s	●
P4.28	Pulse minimum input	0.00kHz~P4.30	0.00kHz	●
P4.29	Corresponding setting of pulse minimum input	-100.0%~100.0%	0.0%	●
P4.30	Pulse maximum input	P4.28~100.00kHz	50.00kHz	●
P4.31	Corresponding setting of pulse maximum input	-100.0%~100.0%	100.0%	●
P4.32	Pulse filter time	0.00s~10.00s	0.10s	●

Function Code	Parameter Name	Setting Range	Default	Property
P4.33	AI curve selection	Unit's digit (AI1 curve selection) Curve 1 (2 points, see P4.13 to P4.16) Curve 2 (2 points, see P4.18 to P4.21) Curve 3 (2 points, see P4.23 to P4.26) Curve 4 (4 points, see A6-00 to A6-07) Curve 5 (4 points, see A6-08 to A6-15) Ten's digit (AI2 curve selection) same as AI1 Hundred's digit (AI3 curve selection) same as AI1	321	●
P4.34	Setting for AI less than minimum input	Unit's digit (Setting for AI1 less than minimum input) 0: Minimum value 1: 0.0% Ten's digit (Setting for AI2 less than minimum input) same as AI1 Hundred's digit (Setting for AI3 less than minimum input) same as AI1	000	●
P4.35	X1 delay time	0.0s~3600.0s	0.0s	○
P4.36	X2 delay time	0.0s~3600.0s	0.0s	○
P4.37	X3 delay time	0.0s~3600.0s	0.0s	○
P4.38	X valid mode selection 1	Unit's digit (X1 valid mode) 0: High level valid 1: Low level valid Ten's digit (X2 valid mode) same as X1 Hundred's digit (X3 valid mode) same as X1 Thousand's digit (X4 valid mode) same as X1 Ten thousand's digit (reserve) same as X1	00000	○
P4.40	AI2 input signal selection	0: Voltage signal 1: Current signal	0	○

Function Code	Parameter Name	Setting Range	Default	Property
P5 : Output Terminals				
P5.00	reserve			
P5.01	reserve	0: No output 1: AC drive running 2: Fault output (stop) 3: Frequency-level detection FDT1 output 4: Frequency reached 5: Zero-speed running (no output at stop) 6: Motor overload pre-warning 7: AC drive overload pre-warning 8: Set count value reached 9: Designated count value reached 10: Length reached 11: PLC cycle complete 12: Accumulative running time reached	0	●
P5.02	Relay function (T/A-T/B-T/C)		2	●
P5.03	reserve	13: Frequency limited 14: Torque limited 15: Ready for RUN 16: AI1 larger than AI2 17: Frequency upper limit reached 18: Frequency lower limit reached (no output at stop) 19: Undervoltage state output 20: Communication setting 21: Reserved 22: Reserved 23: Zero-speed running 2 (having output at stop) 24: Accumulative power-on time reached 25: Frequency level detection FDT2 output 26: Frequency 1 reached 27: Frequency 2 reached 28: Current 1 reached 29: Current 2 reached 30: Timing reached 31: AI1 input limit exceeded 32: Load becoming 0 33: Reverse running 34: Zero current state 35: Module temperature reached	0	●
P5.04	reserve		1	●

Function Code	Parameter Name	Setting Range	Default	Property
P5.05	reserve	36: Software current limit exceeded 37: Frequency lower limit reached (having output at stop) 38: Alarm output 39: Motor overheat warning 40: Current running time reached 41: Fault output (There is no output if it is the coast to stop fault and undervoltage occurs.)	4	●
P5.06	reserve	0: Running frequency	0	●
P5.07	reserve	1: Set frequency 2: Output current 3: Output torque (absolute value)	0	●
P5.08	reserve	4: Output power 5: Output voltage 6: Pulse input 7: AI1 8: AI2 9: AI3 10: Length 11: Count value 12: Communication setting 13: Motor rotational speed 14: Output current 15: Output voltage 16: Output torque (actual value)	1	●
P5.18	Relay 1 output delay time	0.0s~3600.0s	0.0s	●
P5.22	DO valid mode selection	0: Positive logic 1: Negative logic Unit's digit: reserve Ten's digit: Relay 1 valid mode Hundred's digit: reserve Thousand's digit: reserve Ten thousand's digit: reserve	00000	●
P6 : Start/Stop Control				
P6.00	Start mode	0: Direct start 1: Rotational speed tracking restart 2: Pre-excited start (asynchronous motor)	0	●

Function Code	Parameter Name	Setting Range	Default	Property
P6.01	Rotational speed tracking mode	0: From frequency at stop 1: From zero speed 2: From maximum frequency	0	○
P6.02	Rotational speed tracking speed	1~100	20	●
P6.03	Startup frequency	0.00Hz~10.00Hz	0.00Hz	●
P6.04	Startup frequency holding time	0.0s~100.0s	0.0s	○
P6.05	Startup DC braking current/Pre-excited current	0%~100%	0%	○
P6.06	Startup DC braking time/Pre-excited time	0.0s~100.0s	0.0s	○
P6.07	Acceleration/Deceleration mode	0: Linear acceleration/ deceleration 1: S-curve acceleration/ deceleration A 2: S-curve acceleration/ deceleration B	0	○
P6.08	Time proportion of S-curve start segment	0.0%~ (100.0%-P6.09)	30.0%	○
P6.09	Time proportion of S-curve end segment	0.0%~ (100.0%-P6.08)	30.0%	○
P6.10	Stop mode	0: Decelerate to stop 1: Coast to stop	0	●
P6.11	Initial frequency of stop DC braking	0.00Hz to maximum frequency	0.00Hz	●
P6.12	Waiting time of stop DC braking	0.0s~100.0s	0.0s	●
P6.13	Stop DC braking current	0%~100%	0%	●
P6.14	Stop DC braking time	0.0s~100.0s	0.0s	●
P6.15	Brake use ratio	0%~100%	100%	●
P6.18	Rotational speed tracking current	30%~200%	Model dependent	○
P6.21	Degauss time	0.0s~5.0s	Model dependent	○

Function Code	Parameter Name	Setting Range	Default	Property
P7 : Operation Panel and Display				
P7.00	LED display 2	0: Running frequency 1 (Hz) 1: Set frequency (Hz) 2: Bus voltage (V) 3: Output voltage (V) 4: Output current (A) 5: Output power (kW) 6: Output torque (%) 7: DI input status 8: DO output status 9: AI1 voltage (V) 10: AI2 voltage (V) 11: AI3 voltage (V) 12: Count value 13: Length value 14: Load speed display 15: PID setting 16: PID feedback 17: PLC stage 18: Pulse setting frequency(kHz) 19: Running frequency 2 (Hz) 20: Remaining running time 21: AI1 voltage before correction (V) 22: AI2 voltage before correction (V) 23: AI3 voltage before correction (V) 24: Linear speed 25: Current power-on time (Hour) 26: Current running time (Min) 27: Pulse setting frequency (Hz) 28: Communication setting value 29: Encoder feedback speed (Hz) 30: Main frequency X display (Hz) 31: Auxiliary frequency Y display (Hz)	4	○
P7.01	MF.K Key function selection	0: MF.K key disabled 1: Switchover between operation panel control and remote command control (terminal or communication) 2: Switchover between forward rotation and reverse rotation 3: Forward JOG 4: Reverse JOG	0	○

Function Code	Parameter Name	Setting Range	Default	Property
P7.02	STOP/RESET key function	0: STOP/RESET key enabled only in operation panel control 1: STOP/RESET key enabled in any operation mode	1	●
P7.03	LED display running parameters 1	0000-FFFF Bit00: Running frequency 1 (Hz) Bit01: Set frequency (Hz) Bit02: Bus voltage (V) Bit03: Output voltage (V) Bit04: Output current (A) Bit05: Output power (kW) Bit06: Output torque (%) Bit07: DI input status Bit08: DO output status Bit09: AI1 voltage (V) Bit10: AI2 voltage (V) Bit11: AI3 voltage (V) Bit12: Count value Bit13: Length value Bit14: Load speed display Bit15: PID setting	1F	●
P7.04	LED display running parameters 2	0000-FFFF Bit00: PID feedback Bit02: Pulse setting frequency (kHz) Bit03: Running frequency 2 (Hz) Bit04: Remaining running time Bit05: AI1 voltage before correction (V) Bit06: AI2 voltage before correction (V) Bit07: AI3 voltage before correction (V) Bit08: Linear speed Bit09: Current power-on time (Hour) Bit10: Current running time (Min) Bit11: Pulse setting frequency (Hz) Bit12: Communication setting value Bit13: Encoder feedback speed (Hz) Bit14: Main frequency X display (Hz) Bit15: Auxiliary frequency Y display (Hz)	0	●

Function Code	Parameter Name	Setting Range	Default	Property
P7.05	LED display stop parameters	0000~FFFF Bit00: Set frequency (Hz) Bit01: Bus voltage (V) Bit02: DI input status Bit03: DO output status Bit04: AI1 voltage (V) Bit05: AI2 voltage (V) Bit06: AI3 voltage (V) Bit07: Count value Bit08: Length value Bit09: PLC stage Bit10: Load speed Bit11: PID setting Bit12: Pulse setting frequency(kHz)	33	●
P7.06	Load speed display	0.0001~6.5000	1.0000	●
P7.07	Heatsink temperature of inverter module	0.0℃~100.0℃	-	×
P7.08	Product number	-		
P7.09	Accumulative running time	0h~65535h	-	×
P7.10	Software version 1	-	-	×
P7.11	Software version 2	-	-	×
P7.12	Number of decimal places for load speed display	0: 0 decimal place 1: 1 decimal place 2: 2 decimal places 3: 3 decimal places	1	●
P7.13	Accumulative power-on time	0h~65535h	-	×
P7.14	Accumulative power consumption	0kW~65535 kwh	-	×
P7.15	reserve			
P7.16	reserve			

Function Code	Parameter Name	Setting Range	Default	Property
P8 : Auxiliary Functions				
P8.00	JOG running frequency	0.00Hz~maximum frequency	2.00Hz	●
P8.01	JOG acceleration time	0.0s~6500.0s	20.0s	●
P8.02	JOG deceleration time	0.0s~6500.0s	20.0s	●
P8.03	Acceleration time 2	0.0s~6500.0s	Model dependent	●
P8.04	Deceleration time 2	0.0s~6500.0s	Model dependent	●
P8.05	Acceleration time 3	0.0s~6500.0s	Model dependent	●
P8.06	Deceleration time 3	0.0s~6500.0s	Model dependent	●
P8.07	Acceleration time 4	0.0s~6500.0s	Model dependent	●
P8.08	Deceleration time 4	0.0s~6500.0s	Model dependent	●
P8.09	Jump frequency 1	0.00Hz~maximum frequency	0.00Hz	●
P8.10	Jump frequency 2	0.00Hz~maximum frequency	0.00Hz	●
P8.11	Frequency jump amplitude	0.00Hz~maximum frequency	0.01Hz	●
P8.12	Forward/Reverse rotation dead-zone time	0.0s~3000.0s	0.0s	●
P8.13	Reverse control	0: Enabled 1: Disabled	0	●
P8.14	Running mode when set frequency lower than frequency lower limit	0: Run at frequency lower limit 1: Stop 2: Run at zero speed	0	●
P8.15	Droop control	0.00Hz~10.00Hz	0.00Hz	●
P8.16	Accumulative power-on time threshold	0h~65000h	0h	●
P8.17	Accumulative running time threshold	0h~65000h	0h	●
P8.18	Startup protection	0: No 1: Yes	0	●

P8.19	Frequency detection value (FDT1)	0.00Hz~maximum frequency	50.00Hz	●
P8.20	Frequency detection hysteresis (FDT hysteresis 1)	0.0%~100.0% (FDT1 level)	5.0%	●
P8.21	Detection range of frequency reached	0.0%~100.0% (maximum frequency)	0.0%	●
P8.22	Jump frequency during acceleration/decelera	0: Disabled 1: Enabled	0	●
P8.25	Frequency switchover point between acceleration	0.00Hz~maximum frequency	0.00Hz	●
P8.26	Frequency switchover point between deceleration	0.00Hz~maximum frequency	0.00Hz	●
P8.27	Terminal JOG preferred	0: Disabled 1: Enabled	0	●
P8.28	Frequency detection value(FDT2)	0.00Hz~maximum frequency	50.00Hz	●
P8.29	Frequency detection hysteresis (FDT hysteresis 2)	0.0%~100.0% (FDT2 level)	5.0%	●
P8.30	Any frequency reaching detection value 1	0.00Hz~maximum frequency	50.00Hz	●
P8.31	Any frequency reaching detection amplitude 1	0.0%~100.0% (maximum frequency)	0.0%	●
P8.32	Any frequency reaching detection value 2	0.00Hz~maximum frequency	50.00Hz	●
P8.33	Any frequency reaching detection amplitude 2	0.0%~100.0% (maximum frequency)	0.0%	●
P8.34	Zero current detection level	0.0%~300.0% (rated motor current)	5.0%	●
P8.35	Zero current detection delay time	0.01s~600.00s	0.10s	●
P8.36	Output overcurrent threshold	0.0% (no detection) 0.1%~300.0% (rated motor current)	200.0%	●
P8.37	Output overcurrent detection delay time	0.00s~600.00s	0.00s	●

Function Code	Parameter Name	Setting Range	Default	Property
P8.38	Any current reaching 1	0.0%~300.0% (rated motor current)	100.0%	●
P8.39	Any current reaching 1 amplitude	0.0%~300.0% (rated motor current)	0.0%	●
P8.40	Any current reaching 2	0.0%~300.0% (rated motor current)	100.0%	●
P8.41	Any current reaching 2 amplitude	0.0%~300.0% (rated motor current)	0.0%	●
P8.42	Timing function	0: Disabled 1: Enabled	0	●
P8.43	Timing duration source	0: P8.44 1: AI1 2: AI2 3: AI3 (100% of analog input corresponds)	0	●
P8.44	Timing duration	0.0Min~6500.0Min	0.0Min	●
P8.45	AI1 input voltage lower limit	0.00V~P8.46	3.10V	●
P8.46	AI1 input voltage upper limit	P8.45~10.00V	6.80V	●
P8.47	Module temperature threshold	0°C~100°C	75°C	●
P8.48	Cooling fan control	0: Fan working during running 1: Fan working continuously	0	●
P8.49	Wakeup frequency	Dormant frequency (P8.51) to maximum frequency (P0.10)	0.00Hz	●
P8.50	Wakeup delay time	0.0s~6500.0s	0.0s	●
P8.51	Dormant frequency	0.00Hz~wakeup frequency (P8.49)	0.00Hz	●
P8.52	Dormant delay time	0.0s~6500.0s	0.0s	●
P8.53	Current running time reached	0.0Min~6500.0Min	0.0Min	●
P8.54	Output power correction coefficient	0.0%~200.0%	100.0%	●

Function Code	Parameter Name	Setting Range	Default	Property
P9 : Fault and Protection				
P9.00	Motor overload protection selection	0: Disabled 1: Enabled	1	●
P9.01	Motor overload protection gain	0.20~10.00	1.00	●
P9.02	Motor overload warning coefficient	50%~100%	80%	●
P9.07	Short-circuit to ground upon	0: Disabled 1: Enabled	1	●
P9.08	Brake unit opening voltage	200.0~2000.0V	670	●
P9.09	Fault auto reset times	0~20	0	●
P9.10	DO action during fault auto reset	0: Not act 1: Act	0	●
P9.11	Time interval of fault auto reset	0.1s~100.0s	1.0s	●
P9.12	Input phase loss protection/ contactor energizing protection selection	Unit's digit: Input phase loss protection Ten's digit: Contactor energizing protection 0: Disabled 1: Enabled	11	●
P9.13	Output phase loss protection selection	0: Disabled 1: Enabled	1	●

Function Code	Parameter Name	Setting Range	Default	Property
P9.14	1st fault type	E0: No fault E1: Reserved E2: Overcurrent during acceleration E3: Overcurrent during deceleration E4: Overcurrent at constant speed E5: Overvoltage during acceleration E6: Overvoltage during deceleration E7: Overvoltage at constant speed E8: Buffer resistance overload E9: Undervoltage E10: AC drive overload E11: Motor overload E12: Power input phase loss E13: Power output phase loss E14: Module overheat E15: External equipment fault E16: Communication fault E17: Contactor fault E18: Current detection fault E19: Motor auto-tuning fault E20: Encoder/PG card fault E21: EEPROM read-write fault E22: AC drive hardware fault E23: Short circuit to ground E24: Reserved E25: Reserved E26: Accumulative running time reached E27: User-defined fault 1 E28: User-defined fault 2 E29: Accumulative power-on time reached E30: Load becoming 0 E31: PID feedback lost during Running E40: With-wave current limit fault E41: Motor switchover fault during running E42: Too large speed deviation E43: Motor over-speed E45: Motor overheat E51: Initial position fault E60 : Brake resistor fault	—	×
P9.15	2nd fault type	E23: Short circuit to ground E24: Reserved E25: Reserved E26: Accumulative running time reached E27: User-defined fault 1 E28: User-defined fault 2 E29: Accumulative power-on time reached E30: Load becoming 0 E31: PID feedback lost during Running E40: With-wave current limit fault E41: Motor switchover fault during running E42: Too large speed deviation E43: Motor over-speed E45: Motor overheat E51: Initial position fault E60 : Brake resistor fault	—	×

Function Code	Parameter Name	Setting Range	Default	Property
P9.16	3rd (latest) fault type	Same as P9.14、 P9.15	—	×
P9.17	Frequency upon 3rd fault	—	—	×
P9.18	Current upon 3rd fault	—	—	×
P9.19	Bus voltage upon 3rd fault	—	—	×
P9.20	DI status upon 3rd fault	—	—	×
P9.21	Output terminal status upon 3rd fault	—	—	×
P9.22	AC drive status upon 3rd fault	—	—	×
P9.23	Power-on time upon 3rd fault	—	—	×
P9.24	Running time upon 3rd fault	—	—	×
P9.27	Frequency upon 2nd fault	—	—	×
P9.28	Current upon 2nd fault	—	—	×
P9.29	Bus voltage upon 2nd fault	—	—	×
P9.30	DI status upon 2nd fault	—	—	×
P9.31	Output terminal status upon 2nd fault	—	—	×
P9.32	AC drive status upon 2nd fault	—	—	×
P9.33	Power-on time upon 2nd fault	—	—	×
P9.34	Running time upon 2nd fault	—	—	×

Function Code	Parameter Name	Setting Range	Default	Property
P9.37	Frequency upon 1st fault	—	—	×
P9.38	Current upon 1st fault	—	—	×
P9.39	Bus voltage upon 1rd fault	—	—	×
P9.40	DI status upon 1nd fault	—	—	×
P9.41	Output terminal status upon 1nd fault	—	—	×
P9.42	AC drive status upon 1rd fault	—	—	×
P9.43	Power-on time upon 1rd fault	—	—	×
P9.44	Running time upon 1rd fault	—	—	×
P9.47	Fault protection action selection 1	Unit's digit (Motor overload, E11) 0: Coast to stop 1: Stop according to the stop mode 2: Continue to run Ten's digit (Power input phase loss, E12) Hundred's digit (Power output phase loss, E13) Thousand's digit (External equipment fault, E15) Ten thousand's digit (Communication fault, E16)	00000	●
P9.48	Fault protection action selection 2	Unit's digit (Encoder fault, E20) 0: Coast to stop 1: Stop according to the stop Mode Ten's digit (EEPROM read-write fault, E21) Hundred's digit: reserved Thousand's digit (Motor overheat, E25) Ten thousand's digit (Accumulative running time reached, E26)	00000	●

Function Code	Parameter Name	Setting Range	Default	Property
P9.49	Fault protection action selection 3	Unit's digit (User-defined fault 1,E27) Same as unit's digit in P9.47 Ten's digit (User-defined fault 2,E28)) Same as unit's digit in P9.47 Hundred's digit (Accumulative power-on time reached, E29) Same as unit's digit in P9.47 Thousand's digit (Load becoming 0, E30) 0: Coast to stop 1: Stop according to the stop mode 2: Continue to run at 7% of rated motor frequency and resume to the set frequency if the load recovers Ten thousand's digit (PID feedback lost during running, E31) Same as unit's digit in P9.47	00000	●
P9.50	Fault protection action selection 4	Unit's digit (Too large speed deviation, E42) Same as unit's digit in P9.47 Ten's digit (Motor over-speed, E43) Hundred's digit (Initial position fault, E51)	00000	●
P9.54	Frequency selection for continuing to run upon fault	0: Current running frequency 1: Set frequency 2: Frequency upper limit 3: Frequency lower limit 4: Backup frequency upon abnormality	0	●
P9.55	Backup frequency upon abnormality	0.0%~100.0% (maximum frequency)	100.0%	●
P9.56	Type of motor temperature sensor	0: No temperature sensor 1: PT100 2: PT1000	0	●
P9.57	Motor overheat protection	0°C~200°C	110°C	●
P9.58	Motor overheat warning threshold	0°C~200°C	90°C	●

Function Code	Parameter Name	Setting Range	Default	Property
P9.59	Action selection at instantaneous power failure	0: Invalid 1: Decelerate 2: Decelerate to stop	0	●
P9.60	Action pause judging voltage at instantaneous power failure	80.0%~100.0%	85.0%	●
P9.61	Voltage rally judging time at instantaneous power failure	0.00s~100.00s	0.50s	●
P9.62	Action judging voltage at instantaneous power failure	60.0%~100.0%(standard bus voltage)	80.0%	●
P9.63	Protection upon load becoming 0	0: Disabled 1: Enabled	0	●
P9.64	Detection level of load becoming 0	0.0~100.0%	10.0%	●
P9.65	Detection time of load becoming 0	0.0~60.0s	1.0s	●
P9.67	Over-speed detection value	0.0%~50.0% (maximum frequency)	20.0%	●
P9.68	Over-speed detection time	0.0s~60.0s	5.0s	●
P9.69	Detection value of too large speed deviation	0.0%~50.0% (maximum frequency)	20.0%	●
P9.70	Detection time of too large speed deviation	0.0s : Disabled 0.0s~60.0s	5.0s	●
P9.71	instantaneous power failure gain	0~100	40	
P9.72	instantaneous power failure integration time	0~100	30	
P9.73	instantaneous power failure decelerate time	0~300.0s	20.0s	

Function Code	Parameter Name	Setting Range	Default	Property
PA: Fault and Protection				
PA.00	PID setting source	0: PA.01 set 1: AI1 2: AI2 3: AI3 4: Pulse setting (DI5) 5: Communication setting 6: Multi-reference	0	●
PA.01	PID digital setting	0.0%~100.0%	50.0%	●
PA.02	PID feedback source	0: AI1 1: AI2 2: AI3 3: AI1-AI2 4: Pulse setting (DI5) 5: Communication setting 6: AI1 + AI2 7: MAX (AI1 , AI2) 8: MIN (AI1 , AI2)	0	●
PA.03	PID action direction	0: Forward action 1: Reverse action	0	●
PA.04	PID setting feedback range	0~65535	1000	●
PA.05	Proportional gain Kp1	0.0~100.0	20.0	●
PA.06	Integral time Ti1	0.01s~10.00s	2.00s	●
PA.07	Differential time Td1	0.000s~10.000s	0.000s	●
PA.08	Cut-off frequency of PID reverse rotation	0.00~最大频率	2.00Hz	●
PA.09	PID deviation limit	0.0%~100.0%	0.0%	●
PA.10	PID differential limit	0.00%~100.00%	0.10%	●
PA.11	PID setting change time	0.00~650.00s	0.00s	●
PA.12	PID feedback filter time	0.00~60.00s	0.00s	●
PA.13	PID output filter time	0.00~60.00s	0.00s	●

PA.14	Reserved			
PA.15	Proportional gain Kp2	0.0~100.0	20.0	●
PA.16	Integral time Ti2	0.01s~10.00s	2.00s	●
PA.17	Differential time Td2	0.000s~10.000s	0.000s	●
PA.18	PID parameter switchover condition	0: No switchover 1: Switchover via DI 2: Automatic switchover based on deviation	0	●
PA.19	PID parameter switchover deviation 1	0.0%~PA.20	20.0%	●
PA.20	PID parameter switchover deviation 2	PA.19~100.0%	80.0%	●
PA.21	PID initial value	0.0%~100.0%	0.0%	●
PA.22	PID initial value holding time	0.00~650.00s	0.00s	●
PA.23	Maximum deviation between two PID outputs in forward direction	0.00%~100.00%	1.00%	●
PA.24	Maximum deviation between two PID outputs in reverse direction	0.00%~100.00%	1.00%	●
PA.25	PID integral property	Unit's digit (Integral separated) 0: Invalid 1: Valid Ten's digit (Whether to stop integral operation when the output reaches the limit) 0: Continue integral operation 1: Stop integral operation	00	●
PA.26	Detection value of PID feedback loss	0.0% : Not judging feedback loss 0.1%~100.0%	0.0%	●
PA.27	Detection time of PID feedback loss	0.0s~20.0s	0.0s	●
PA.28	PID operation at stop	0: No PID operation at stop 1: PID operation at stop	0	●

Function Code	Parameter Name	Setting Range	Default	Property
Pb: Swing Frequency, Fixed				
Pb.00	Swing frequency setting mode	0: Relative to the central frequency 1: Relative to the maximum frequency	0	●
Pb.01	Swing frequency amplitude	0.0%~100.0%	0.0%	●
Pb.02	Jump frequency amplitude	0.0%~50.0%	0.0%	●
Pb.03	Swing frequency cycle	0.1s~3000.0s	10.0s	●
Pb.04	Triangular wave rising time coefficient	0.1%~100.0%	50.0%	●
Pb.05	Set length	0m~65535m	1000m	●
Pb.06	Actual length	0m~65535m	0m	●
Pb.07	Number of pulses per meter	0.1~6553.5	100.0	●
Pb.08	Set count value	1~65535	1000	●
Pb.09	Designated count value	1~65535	1000	●
PC: Multi-Reference and Simple PLC Function				
PC.00	Reference 0	-100.0%~100.0%	0.0%	●
PC.01	Reference 1	-100.0%~100.0%	0.0%	●
PC.02	Reference 2	-100.0%~100.0%	0.0%	●
PC.03	Reference 3	-100.0%~100.0%	0.0%	●
PC.04	Reference 4	-100.0%~100.0%	0.0%	●
PC.05	Reference 5	-100.0%~100.0%	0.0%	●
PC.06	Reference 6	-100.0%~100.0%	0.0%	●
PC.07	Reference 7	-100.0%~100.0%	0.0%	●
PC.08	Reference 8	-100.0%~100.0%	0.0%	●
PC.09	Reference 9	-100.0%~100.0%	0.0%	●
PC.10	Reference 10	-100.0%~100.0%	0.0%	●

Function Code	Parameter Name	Setting Range	Default	Property
PC.11	Reference 11	-100.0%~100.0%	0.0%	●
PC.12	Reference 12	-100.0%~100.0%	0.0%	●
PC.13	Reference 13	-100.0%~100.0%	0.0%	●
PC.14	Reference 14	-100.0%~100.0%	0.0%	●
PC.15	Reference 15	-100.0%~100.0%	0.0%	●
PC.16	Simple PLC running mode	0: Stop after the AC drive runs one cycle 1: Keep final values after the AC drive runs one cycle 2: Repeat after the AC drive runs one cycle	0	●
PC.17	Simple PLC retentive selection	Unit's digit (Retentive upon power failure) 0: No 1: Yes Ten's digit (Retentive upon stop) 0: No 1: Yes	00	●
PC.18	Running time of simple PLC reference 0	0.0s (h) ~6553.5s (h)	0.0s (h)	●
PC.19	Acceleration/deceleration time of simple PLC reference 0	0~3	0	●
PC.20	Running time of simple PLC reference 1	0.0s (h) ~6553.5s (h)	0.0s (h)	●
PC.21	Acceleration/deceleration time of simple PLC reference 1	0~3	0	●
PC.22	Running time of simple PLC reference 2	0.0s (h) ~6553.5s (h)	0.0s (h)	●
PC.23	Acceleration/deceleration time of simple PLC reference 2	0~3	0	●
PC.24	Running time of simple PLC reference 3	0.0s (h) ~6553.5s (h)	0.0s (h)	●

Function Code	Parameter Name	Setting Range	Default	Property
PC.25	Acceleration/deceleration time of simple PLC reference 3	0~3	0	●
PC.26	Running time of simple PLC reference 4	0.0s (h) ~6553.5s (h)	0.0s (h)	●
PC.27	Acceleration/deceleration time of simple PLC reference 4	0~3	0	●
PC.28	Running time of simple PLC reference 5	0.0s (h) ~6553.5s (h)	0.0s (h)	●
PC.29	Acceleration/deceleration time of simple PLC reference 5	0~3	0	●
PC.30	Running time of simple PLC reference 6	0.0s (h) ~6553.5s (h)	0.0s (h)	●
PC.31	Acceleration/deceleration time of simple PLC reference 6	0~3	0	●
PC.32	Running time of simple PLC reference 7	0.0s (h) ~6553.5s (h)	0.0s (h)	●
PC.33	Acceleration/deceleration time of simple PLC reference 7	0~3	0	●
PC.34	Running time of simple PLC reference 8	0.0s (h) ~6553.5s (h)	0.0s (h)	●
PC.35	Acceleration/deceleration time of simple PLC reference 8	0~3	0	●
PC.36	Running time of simple PLC reference 9	0.0s (h) ~6553.5s (h)	0.0s (h)	●
PC.37	Acceleration/deceleration time of simple PLC reference 9	0~3	0	●
PC.38	Running time of simple PLC reference 10	0.0s (h) ~6553.5s (h)	0.0s (h)	●
PC.39	Acceleration/deceleration time of simple PLC reference 10	0~3	0	●

Function Code	Parameter Name	Setting Range	Default	Property
PC.40	Running time of simple PLC reference 11	0.0s (h) ~6553.5s (h)	0.0s (h)	●
PC.41	Acceleration/deceleration time of simple PLC reference 11	0~3	0	●
PC.42	Running time of simple PLC reference 12	0.0s (h) ~6553.5s (h)	0.0s (h)	●
PC.43	Acceleration/deceleration time of simple PLC reference 12	0~3	0	●
PC.44	Running time of simple PLC reference 13	0.0s (h) ~6553.5s (h)	0.0s (h)	●
PC.45	Acceleration/deceleration time of simple PLC reference 13	0~3	0	●
PC.46	Running time of simple PLC reference 14	0.0s (h) ~6553.5s (h)	0.0s (h)	●
PC.47	Acceleration/deceleration time of simple PLC reference 14	0~3	0	●
PC.48	Running time of simple PLC reference 15	0.0s (h) ~6553.5s (h)	0.0s (h)	●
PC.49	Acceleration/deceleration time of simple PLC reference 15	0~3	0	●
PC.50	Time unit of simple PLC running	0: s (second) 1:h (hour)	0	●
PC.51	Reference 0 source	0: Set by FC-00 1: AI1 2: AI2 3: AI3 4: Pulse setting 5: PID 6: Set by preset frequency (F0-08), modified via terminal UP/DOWN	0	●

Function Code	Parameter Name	Setting Range	Default	Property
Pd: Communication Parameters				
Pd.00	Baud rate	Unit's digit : MODBUS (bps) 0 : 300 1 : 600 2 : 1200 3 : 2400 4 : 4800 5 : 9600 6 : 19200 7 : 38400 8 : 57600 9 : 115200 Ten's digit : reserve Hundred's digit : reserve	0005	●
Pd.01	Data format	0 : No check, data format (1-8-N-2) 1 : Even parity check, data format (1-8-E-1) 2 : Odd Parity check, data format (1-8-O-1) 3 : No check, data format (1-8-N-1)	3	●
Pd.02	Local address	1~247, 0 :Broadcast address	1	●
Pd.03	Response delay	0ms~20ms	2	●
Pd.04	Communication timeout	0.0 (invalid) , 0.1s~60.0s	0.0	●
Pd.05	Modbus protocol selection and PROFIBUS-DP data format	Unit's digit : MODBUS 0: Non-standard Modbus protocol 1: Standard Modbus protocol Ten's digit: reserve	01	●
Pd.06	Communication reading current resolution	0 : 0.01A 1 : 0.1A	0	●

Function Code	Parameter Name	Setting Range	Default	Property
PP: Function Code Management				
PP.00	User password	0~65535	0	●
PP.01	Restore default settings	0: No operation 01: Restore factory settings except motor parameters 02: Clear records 04: Restore user backup parameters 501: Back up current user parameters	0	○
PP.02	AC drive parameter display property	Unit's digit (Group U display selection) 0: Not display 1: Display Ten's digit (Group A display selection) 0: Not display 1: Display	11	○
A0: Torque Control and Restricting Parameters				
A0.00	Speed/Torque control selection	0: Speed control 1: Torque control	0	○
A0.01	Torque setting source in torque control	0: Digital setting (A0-03) 1: AI1 2: AI2 3: AI3 5: Communication setting 6: MIN (AI1, AI2) 7: MAX (AI1, AI2) Full range of values 1~7 corresponds to the digital setting of A0.03.	0	○
A0.03	Torque digital setting in torque control	-200.0%~200.0%	150.0%	●
A0.05	Forward maximum frequency in torque control	0.00Hz~maximum frequency	50.00Hz	●
A0.06	Reverse maximum frequency in torque control	0.00Hz~maximum frequency	50.00Hz	●
A0.07	Acceleration time in torque control	0.00s~65000s	0.00s	●
A0.08	Deceleration time in torque control	0.00s~65000s	0.00s	●

Function Code	Parameter Name	Setting Range	Default	Property
A1: Virtual DI (VDI)/Virtual DO (VDO)				
A1.00	VX1 function selection	0~59	0	○
A1.01	VX2 function selection	0~59	0	○
A1.02	VX3 function selection	0~59	0	○
A1.03	VX4 function selection	0~59	0	○
A1.04	VX5 function selection	0~59	0	○
A1.05	VX state setting mode	0: Decided by state of VYx 1: Decided by A1-06 Unit's digit (VX1) Ten's digit (VX2) Hundred's digit (VX3) Thousand's digit (VX4) Ten thousand's digit (VX5)	00000	○
A1.06	VX state selection	0: Invalid 1: Valid Unit's digit (VX1) Ten's digit (VX2) Hundred's digit (VX3) Thousand's digit (VX4) Ten thousand's digit (VX5)	00000	○
A1.07	Function selection for AI1 used as X	0~59	0	○
A1.08	Function selection for AI2 used as X	0~59	0	○
A1.09	Function selection for AI3 used as X	0~59	0	○
A1.10	State selection for AI used as X	0: High level valid 1: Low level valid Unit's digit (AI1) Ten's digit (AI2) Hundred's digit (AI3)	000	○

A1.11	VY1 function selection	0: Short with physical Xx internally 1-40: Refer to function selection of physical X in group P5.	0	●
A1.12	VY2 function selection	0: Short with physical Xx internally 1-40: Refer to function selection of physical X in group P5.	0	●
A1.13	VY3 function selection	0: Short with physical Xx internally 1-40: Refer to function selection of physical X in group P5.	0	●
A1.14	VY4 function selection	0: Short with physical Xx internally 1-40: Refer to function selection of physical X in group P5.	0	●
A1.15	VY5 function selection	0: Short with physical Xx internally 1-40: Refer to function selection of physical X in group P5.	0	●
A1.16	VX1 output delay	0.0s~3600.0s	0.0s	●
A1.17	VX2 output delay	0.0s~3600.0s	0.0s	●
A1.18	VX3 output delay	0.0s~3600.0s	0.0s	●
A1.19	VX4 output delay	0.0s~3600.0s	0.0s	●
A1.20	VX5 output delay	0.0s~3600.0s	0.0s	●
A1.21	VY state selection	0: Positive logic 1: Reverse logic Unit's digit : VY1 Ten's digit : VY2 Hundred's digit : VY3 Thousand's digit : VY4 Ten thousand's digit : VY5	00000	●

Function Code	Parameter Name	Setting Range	Default	Property
A2: Motor 2 Parameters				
A2.00	Motor type selection	0: Common asynchronous motor 1: Variable frequency asynchronous motor	0	○
A2.01	Rated motor power	0.1kW~1000.0kW	Model dependent	○
A2.02	Rated motor voltage	1V~2000V	Model dependent	○
A2.03	Rated motor current	0.01~655.35 A (AC drive power ≤ 55 kW) 0.1~6553.5 A (AC drive power > 55 kW)	Model dependent	○
A2.04	Rated motor frequency	0.01 Hz to maximum frequency	Model dependent	○
A2.05	Rated motor rotational speed	1rpm~65535rpm	Model dependent	○
A2.06	Stator resistance (asynchronous motor)	0.001~65.535 Ω (AC drive power ≤ 55 kW) 0.0001~6.5535 Ω (AC drive power > 55 kW)	Model dependent	○
A2.07	Rotor resistance (asynchronous motor)	0.001~65.535 Ω (AC drive power ≤ 55 kW) 0.0001~6.5535 Ω (AC drive power > 55 kW)	Model dependent	○

Function Code	Parameter Name	Setting Range	Default	Property
A2.08	Leakage inductive reactance (asynchronous motor)	0.01–655.35 mH (AC drive power ≤ 55 kW) 0.001–65.535 mH (AC drive power > 55 kW)	Model dependent	○
A2.09	Mutual inductive reactance (asynchronous motor)	0.1–6553.5 mH (AC drive power ≤ 55 kW) 0.01–655.35 mH (AC drive power > 55 kW)	Model dependent	○
A2.10	No-load current (asynchronous motor)	0.01 to F1-03 (AC drive power ≤ 55 kW) 0.1 to F1-03 (AC drive power > 55 kW)	Model dependent	○
A2.37	Auto-tuning selection	0: No auto-tuning 1: Asynchronous motor static auto-tuning 2: Asynchronous motor complete auto-tuning	0	○
A2.38	Speed loop proportional gain 1	1~100	30	●
A2.39	Speed loop integral time 1	0.01s~10.00s	0.50s	●
A2.40	Switchover frequency 1	0.00~A2.43	5.00Hz	●
A2.41	Speed loop proportional gain 2	1~100	20	●
A2.42	Speed loop integral time 2	0.01s~10.00s	1.00s	●
A2.43	Switchover frequency 2	A2.40~maximum output frequency	10.00Hz	●
A2.44	Vector control slip gain	50%~200%	100%	●
A2.45	Vector control slip gain	50%~200%	0.000s	●
A2.46	Time constant of speed loop filter	0.000s~1.000s	64	●
A2.47	Torque upper limit source in speed control mode	0: P2.10 1: AI1 2: AI2 3: AI3 4: Pulse setting (X5) 5: Communication setting	0	●

Function Code	Parameter Name	Setting Range	Default	Property
A2.48	Digital setting of torque upper limit in speed control mode	0.0%~200.0%	150.0%	●
A2.51	Excitation adjustment proportional gain	0~60000	2000	●
A2.52	Excitation adjustment integral gain	0~60000	1300	●
A2.53	Torque adjustment proportional gain	0~60000	2000	●
A2.54	Torque adjustment integral gain	0~60000	1300	●
A2.55	Speed loop integral property	Unit's digit: integral separation 0: Disabled 1: Enabled	0	●
A2.61	Motor 2 control mode	0: Voltage/Frequency (V/F) control 1: Sensorless flux vector control	0	○
A2.62	Motor 2 acceleration/ deceleration time	0: Same as motor 1 1: Acceleration/Deceleration time 1 2: Acceleration/Deceleration time 2 3: Acceleration/Deceleration time 3 4: Acceleration/Deceleration time 4	0	●
A2.63	Motor 2 torque boost	0.0% : Automatic torque boost 0.1%~30.0%	Model dependent	●
A2.65	Motor 2 oscillation suppression gain	0~100	Model dependent	●
A5: Control Optimization Parameters				
A5.00	DPWM switchover frequency	0.00Hz~maximum output frequency	8.00Hz	●
A5.01	PWM modulation mode	0: Asynchronous modulation 1: Synchronous modulation	0	●
A5.02	Dead zone compensation mode selection	0: No compensation 1: Compensation mode 1	1	●
A5.03	Random PWM depth	0: Random PWM invalid 1~10	0	●
A5.04	Rapid current limit	0: Disabled 1: Enabled	1	●

Function Code	Parameter Name	Setting Range	Default	Property
A5.05	Current detection compensation	0~100	5	●
A5.06	Undervoltage threshold	200.0~2000.0V	Model dependent	●
A5.07	SFVC optimization mode selection	1: Optimization mode 1 2: Optimization mode 2	2	●
A5.08	Dead-zone time adjustment	100%~200%	150%	●
A5.09	Overvoltage threshold	200.0~2000.0V	Model dependent	●
A6: AI Curve Setting				
A6.00	AI curve 4 minimum input	-10.00V~A6.02	0.00V	●
A6.01	Corresponding setting of AI curve 4 minimum input	-100.0%~+100.0%	0.0%	●
A6.02	AI curve 4 inflexion 1 input	A6.00~A6.04	3.00V	●
A6.03	Corresponding setting of AI curve 4 inflexion 1 input	-100.0%~+100.0%	30.0%	●
A6.04	AI curve 4 inflexion 1 input	A6.02~A6.06	6.00V	●
A6.05	Corresponding setting of AI curve 4 inflexion 1 input	-100.0%~+100.0%	60.0%	●
A6.06	AI curve 4 maximum input	A6.06~+10.00V	10.00V	●
A6.07	Corresponding setting of AI curve 4 maximum input	-100.0%~+100.0%	100.0%	●
A6.08	AI curve 5 minimum input	-10.00V~A6.10	-10.00V	●
A6.09	Corresponding setting of AI curve 5 minimum input	-100.0%~+100.0%	-100.0%	●
A6.10	AI curve 5 inflexion 1 input	A6.08~A6.12	-3.00V	●
A6.11	Corresponding setting of AI curve 5 inflexion 1 input	-100.0%~+100.0%	-30.0%	●
A6.12	AI curve 5 inflexion 1 input	A6.10~A6.14	3.00V	●

Function Code	Parameter Name	Setting Range	Default	Property
A6.13	Corresponding setting of AI curve 5 inflexion 1 input	-100.0%~+100.0%	30.0%	●
A6.14	AI curve 5 maximum input	A6.12~+10.00V	10.00V	●
A6.15	Corresponding setting of AI curve 5 maximum input	-100.0%~+100.0%	100.0%	●
A6.24	Jump point of AI1 input corresponding setting	-100.0%~100.0%	0.0%	●
A6.25	Jump amplitude of AI1 input corresponding setting	0.0%~100.0%	0.5%	●
A6.26	Jump point of AI2 input corresponding setting	-100.0%~100.0%	0.0%	●
A6.27	Jump amplitude of AI2 input corresponding setting	0.0%~100.0%	0.5%	●
A6.28	Jump point of AI3 input corresponding setting	-100.0%~100.0%	0.0%	●
A6.29	Jump amplitude of AI3 input corresponding setting	0.0%~100.0%	0.5%	●

Monitoring Parameters

Function Code	Parameter Name	Min. Unit	Communication Address
D0: Standard Monitoring Parameters			
D0.01	Running frequency (Hz)	0.01Hz	7000H
D0.01	Set frequency (Hz)	0.01Hz	7001H
D0.02	Bus voltage	0.1V	7002H
D0.03	Output voltage	1V	7003H
D0.04	Output current	0.01A	7004H
D0.05	Output power	0.1kW	7005H
D0.06	Output torque	0.1%	7006H
D0.07	Digital input(X) state	1	7007H
D0.08	Digital output(Y) state	1	7008H
D0.09	AI1 voltage (V)	0.01V	7009H
D0.10	AI2 voltage (V)	0.01V	700AH
D0.11	AI3 voltage (V)	0.01V	700BH
D0.12	Count value	1	700CH
D0.13	Length value	1	700DH
D0.14	Load speed	1	700EH
D0.15	PID setting	1	700FH
D0.16	PID feedback	1	7010H
D0.17	PLC stage	1	7011H
D0.18	Input pulse frequency (Hz)	0.01kHz	7012H
D0.19	Feedback speed	0.1Hz	7013H
D0.20	Remaining running time	0.1Min	7014H
D0.21	AI1 voltage before correction	0.001V	7015H
D0.22	AI2 voltage (V)/current (mA) before correction	0.001V	7016H
D0.23	AI3 voltage before correction	0.001V	7017H

Function Code	Parameter Name	Min. Unit	Communication Address
D0.24	Linear speed	1m/Min	7018H
D0.25	Accumulative power-on time	1Min	7019H
D0.26	Accumulative running time	0.1Min	701AH
D0.27	Pulse input frequency	1Hz	701BH
D0.28	Communication setting value	0.01%	701CH
D0.29	Encoder feedback speed	0.01Hz	701DH
D0.30	Main frequency X	0.01Hz	701EH
D0.31	Auxiliary frequency Y	0.01Hz	701FH
D0.32	Viewing any register address value	1	7020H
D0.34	Motor temperature	1℃	7022H
D0.35	Target torque	0.1%	7023H
D0.37	Power factor angle	0.1°	7025H
D0.39	Target voltage upon V/F separation	1V	7027H
D0.40	Output voltage upon V/F separation	1V	7028H
D0.41	DI state visual display	1	7029H
D0.42	DO state visual display	1	702AH
D0.43	DI function state visual display 1	1	702BH
D0.44	DI function state visual display 2	1	702CH
D0.45	Fault information	1	702DH
D0.59	Current set frequency	0.01%	703BH
D0.60	Current running frequency	0.01%	703CH
D0.61	AC drive running state	1	703DH
D0.65	Torque upper limit	0.01%	7041H
D0.74	Torque output	1%	7047H

Summary of fault information

Display	Fault Name	Display	Fault Name
E01	Inverter unit protection	E18	Current detection fault
E02	Overcurrent during acceleration	E19	Motor auto-tuning fault
E03	Overcurrent during deceleration	E20	Encoder fault
E04	Overcurrent at constant speed	E21	EEPROM readwrite fault
E05	Overvoltage during acceleration	E22	AC drive hardware fault
E06	Overvoltage during deceleration	E23	Short circuit to ground
E07	Overvoltage at constant speed	E26	Accumulative running time reached
E08	Control power supply fault	E29	Accumulative power-on time reached
E09	Undervoltage	E30	Load becoming 0
E10	AC drive overload	E31	PID feedback lost during running
E11	Motor overload	E40	Pulse-by-pulse current limit fault
E12	Power input phase loss	E41	Motor switchover fault during running
E13	Power output phase loss	E42	Too large speed deviation
E14	Module overheat	E43	Motor over-speed
E15	External equipment fault	E45	Motor overheat
E16	Communication fault	E51	Initial position fault
E17	Contactors fault	E60	Braking resistor failure

Warranty commitment

The warranty scope only refers to the inverter itself, and the warranty period starts from the date of shipment from the company.

1. The warranty period of this product is within twelve months after purchase (except for products exported to foreign countries/non-standard machines).

2. If the failure is caused by the following reasons, even within the warranty period, it is also a paid maintenance:

- . Problems caused by incorrect operation or self-repair and modification without permission;

- . Problems caused by the use of frequency converters beyond the requirements of the standard specifications;

- . Damage caused by fall or rough handling after purchase;

- . Problems or failures caused by use in an environment that does not meet the requirements of the manual; damage to the inverter caused by incorrect wiring;

- . Failures caused by earthquakes, fires, feng shui disasters, lightning strikes, abnormal voltages or other natural disasters and related reasons.

- . For malfunctioning products, the company has the right to entrust others to be responsible for warranty matters.

3. Relevant service fees are calculated according to actual costs, and if there is an agreement, the agreement shall prevail.

4. The company's sales, production, and agency agencies all over the country can provide after-sales service for this product.

5. In the following cases, the manufacturer has the right not to provide warranty services:

- . When the manufacturer's brand, trademark, serial number, nameplate and other marks on the product are damaged or unrecognizable;

- . When the user fails to pay the purchase price in accordance with the "Purchase and Sale Contract" signed by both parties;

- . When the user deliberately conceals the improper use of the product during installation, wiring, operation, maintenance or other processes from the manufacturer's after-sales service provider.