

# Installation & Operation Manual

## M21

Ver.1.1



## Conventions used in this manual

In the manual the following symbols will be used:



Generic danger Failure to comply with the safety regulations that follow can irreparably damage the controller or equipment.



Electric shock risk Failure to comply with the safety regulations that follow can cause death or serious personal injury.

## WARNINGS

**Read this manual carefully before any operation.**

Please keep this manual for future use.



### WARNING!!

- Before carrying out any installation or maintenance operation, controller must be disconnected from the power supply;
- Don't open the cover during running the controller;
- Don't put wire, metal bar filaments etc into the controller;
- Don't splash water or other liquid over the controller;



### CAUTION

- The electrical and hydraulic connections must be carried out by competent, skilled, qualified personnel;
- Never connect AC power to output uvw terminals;
- Ensure the motor, controller and power specifications matching;
- Don't install the controller in the following condition;

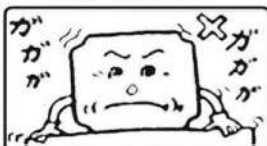

mechanical shock

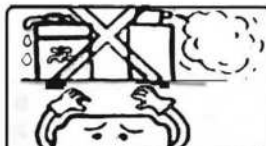

corrosive gas or  
corrosive liquid



Extreme heat and cold,  
acceptable temperature  
range: -25°C +55°C

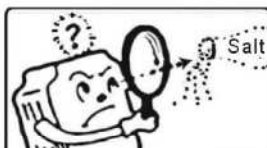

Salt mist corrosion



Rain and Moisture



flammable material:  
solvent

## TABLE OF CONTENTS

<b>1 INTRODUCTION</b>	.1.
1.1 Applications	.1.
1.2 Technical parameter & features	.1.
1.3 Controller components	.3.
<b>2 INSTALLATION</b>	.5.
2.1 Electrical connection to the power supply line and electrical pump	.5.
2.2 Function switch setting	.6.
2.3 Parameter Calibration setting & erasing	.7.
<b>3 ELECTRICAL CONNECTION</b>	.8.
3.1 Installing liquid probe & float switch	.8.
3.2 Electrical connection for different application	.9.
3.2.1 Water supply by liquid level control through float switch or liquid probe	.9.
3.2.2 Water supply by pressure control through pressure switch & pressure tank	.14.
3.2.3 Drainage by liquid level control through float switch & liquid probe	.18.
<b>4 BASIC OPERATION</b>	.21.
4.1 Switching to MANULA mode	.21.
4.2 Switching to AUTO mode	.21.
4.3 Pump protection	.21.
4.4 Pump last five failure record displaying	.21.
4.5 Pump accumulative running time displaying	.22.
<b>5 COMMUNICATION LINK</b>	.23.
5.1 Basic Function	.24.
5.2 Special Application	.24.
5.3 Technical parameter	.24.
<b>6 TROUBLE SHOOTING GUIDE</b>	.25.

## **RESPONSIBILITY**

The manufacturer is not liable for malfunctioning if the product has not correctly been installed, damaged, modified, and /or run outside the recommended work range or run outside the recommended work range or in contrast with other indications given in this manual.

The manufacturer declines all responsibility for possible errors in this operation manual, if due to misprints or errors in copying.

The manufacturer reserves the right to make any modifications to products that it may consider necessary or useful, without affecting the essential characteristics.

## **1 INTRODUCTION**

Thank you for choosing our products, we will supply you with cordial and well-around service as well as ever.

Intelligent Pump Controller model M21 is an easy to use, programmable controlling & protection device for direct start, single phase deep well submersible pump, centrifugal pump, pipeline pump etc with output power from 0.37KW-2.2KW (0.5HP-3HP)

Model M21 has many operation modes by adopting different electric installations. An important feature that makes the difference between Model M21 and common On/Off pump control box is the probe / sensor free in the well. Our special design makes it a very reliable and sensitive protection against pump dry run without installation probe / sensor in the well.

### **1.1 Applications**

Model M21 is useful in all cases we need to control and protect single pump managing its turn-on and turn off by different electric installations.

Typical usage scenarios include:

- Houses
- Flats
- Holidays houses
- Farms
- Water supply from wells
- Irrigations of greenhouses, gardens, agriculture
- Rain water reuse
- Industrial plants
- Waste water tank / Sewage sink

### **1.2 Technical parameter & features**

#### **Main features:**

- Built In function switch
  - applied for water supply by liquid level control through float switch or liquid probe
  - applied for water supply by pressure control through pressure switch and pressure tank
  - applied for drainage by liquid level control through float switch or liquid probe
- Automatic stops the pump in the case of water shortage, protecting it from dry running without installing float switch or liquid probe in the well
- Auto / Manual switch
- Dynamic LCD displaying pump running state
- Protect the pump against many faults
- Push Button Calibration
- Pump Accumulative Running Time Displaying
- Pump Last Five Fault Record Displaying
- RS485 Communication
- Starts and stops the pump in accordance with the different liquid level or pressure setting







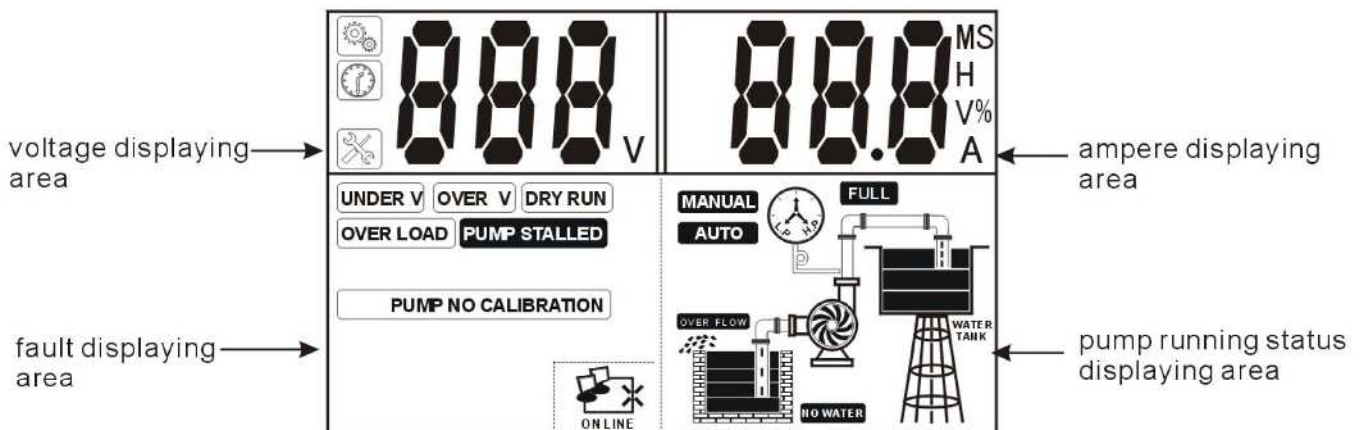
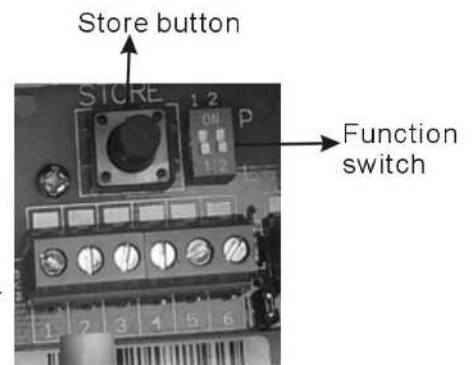
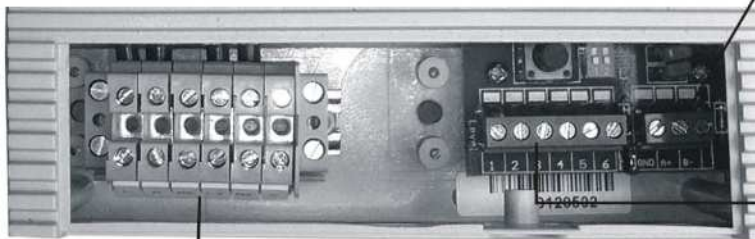
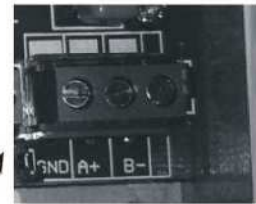
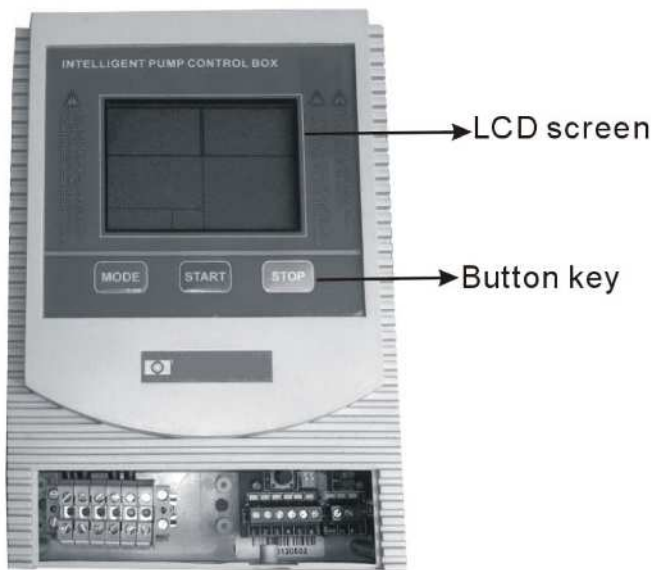

The following chart shows main technical parameters of Model M21

<b>Main technical characteristic</b>	
Control characteristic	double liquid level control
	pressure control
Control method	Manual / Auto
Liquid level control characteristic	pulse electrode probe & float switch
Pressure control characteristic	pressure switch (n/c) & pressure tank
<b>Main technical data</b>	
Rated output power	0.37KW-2.2KW (0.5HP-3HP)
Rated input voltage	AC220V/50HZ Single Phase
Trip response time of over load	5sec-5min
Trip response time of open phase	<2sec
Trip response time of short circuit	<0.1sec
Trip response time of under / over voltage	<5sec
Trip response time of dry run	6sec
Recovery time of over load	30min
Recovery time of under / over voltage	5min
Recovery time of dry run	30min
Trip voltage of over voltage	253V
Trip voltage of under voltage	187V
Liquid level transfer distance	≤1000m
Protection function	Dry run Over load Transient surge Under voltage Over voltage Pump stalled Short circuit
<b>Main installation data</b>	
Working temperature	-25℃ -- +55℃
Working humidity	20% - 90%RH, no drips concreateed
Degree of protection	IP22
Install position	Vertical
Unit dimensions ( L x W x H)	16 x 8.2 x 22.8 cm
Unit weight (net)	1.3kg
<b>RS485 technical data</b>	
Physics Interface	RS485 Bus Interface: asynchronism semiduplex
Baud rate	1200 bps、2400 bps、4800 bps、9600bps Default: 9600bps
Protocol type	MODBUS Protocol (RTU)

### 1.3 Controller components



## Meaning of the icons shown on the LCD

Icon	Meaning/Description
	pump parameter configuration icon, when this icon appears, pump control box is in parameter adjusting manual;
	time displaying icon, when this icon appears, it means pump control box is displaying some parameter of time, eg: pump accumulative running time (unit: hour); counting down etc
	pump fault icon, when this icon appears, it means pump control box is displaying some fault information;
 ON LINE	network connection error icon, when this icon appears, it means there is no network connections or network connection error between pump control box and SC(slave controller) or computer;
 ON LINE	network normal connection icon, when this icon appears, it means the network connection between pump control box and SC (slave controller) or computer is normal;
<b>V</b>	voltage
<b>M</b>	minute
<b>S</b>	second
<b>H</b>	hour
%	percent
<b>A</b>	ampere
	pump running
	pump stops running
	low pressure or lack of pressure in the pipeline or pressure tank
	high pressure or full of pressure in the pipeline or pressure tank

## 2 INSTALLATION

### 2.1 Electrical connection to the power supply line and electrical pump

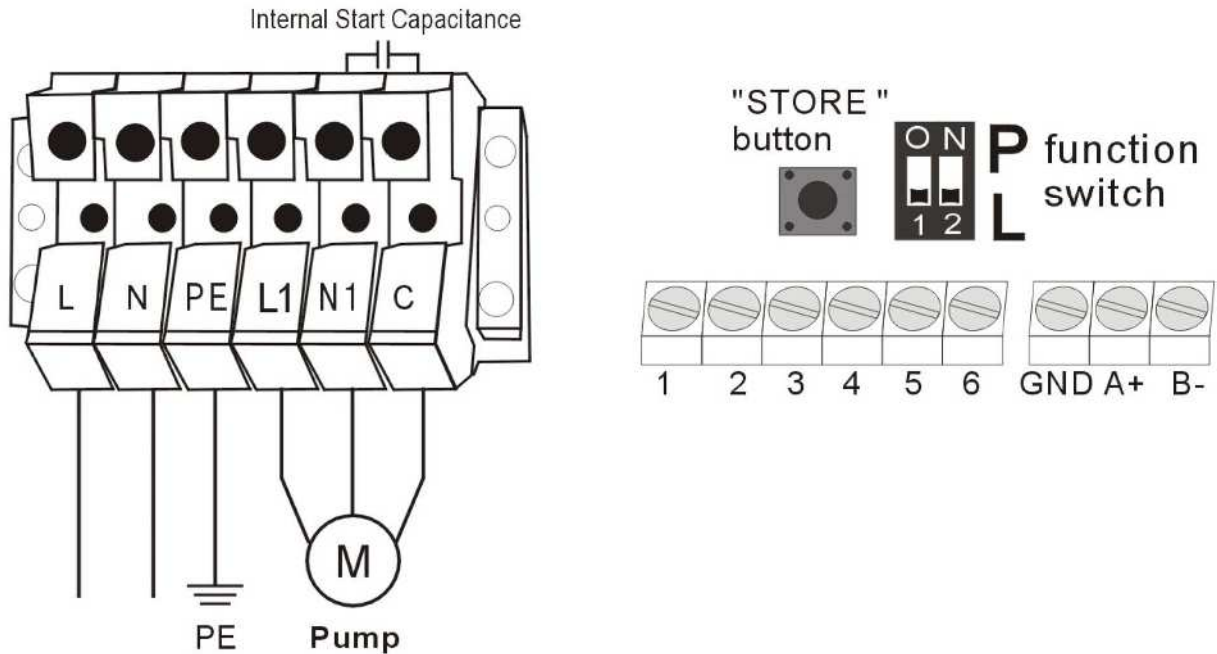

**DANGER** Electric shock risk

Before carrying out any installation or maintenance operation, the M21 should be disconnected from the power supply and one should wait at least 2 minutes before opening the appliance.



Never connect AC power to output UV W terminals.



Don't put wire, metal bar filaments etc into the controller.



Ensure the motor, controller and power specifications matching.



The electrical and hydraulic connections must be carried out by competent, skilled, qualified personnel.



## 2.2 Function switch setting

Pump users can set the function switch to meet different application requirement, before setting the function switch, the M21 should be disconnected from the power supply, after complete the setting, apply power to M21 and observe the application sign displayed on the LCD conforming to the following list.

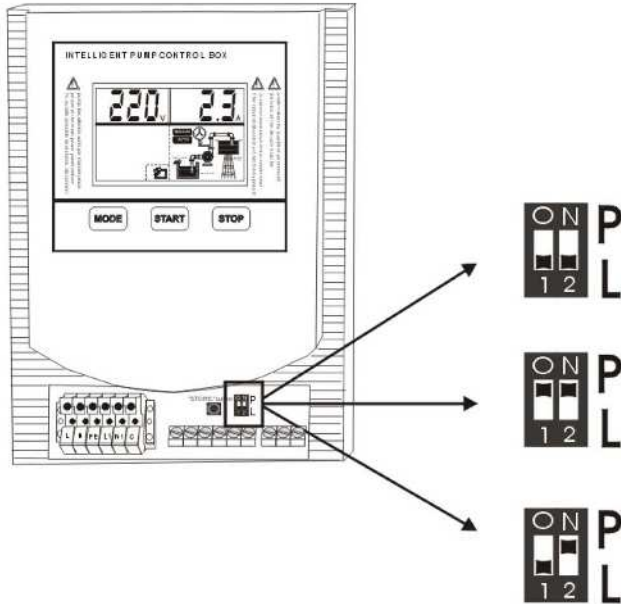

Item	Swith position	Messages & Graphic	Application
1			Applied for water supply or drainage by liquid level control through float switch or liquid sensor
2			Applied for water supply by pressure control through pressure switch & pressure tank
3			Applied for drainage by liquid level control through float switch & liquid probe

## 2.3 Parameter Calibration setting & erasing

To achieve best level of protection of the pump, it is essential that parameter calibration must be done immediately after successful pump installation or pump maintenance.

### Setting the parameter calibration

- Press the **MODE** key to switch to manual state, make sure the pump not running and LCD screen displaying:

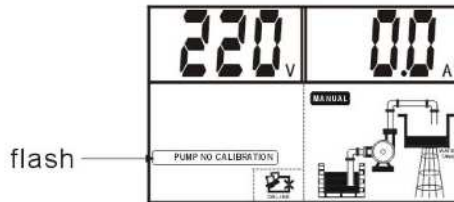

- Press the **START** key to run pump, confirm the pump and all pipe network in normal working state (including voltage, running ampere et); LCD screen displaying:

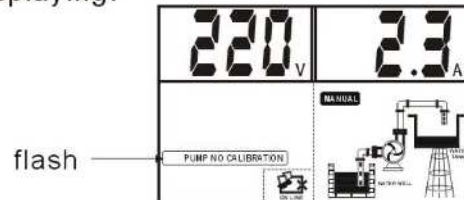

- Press the **STORE** button; The M21 makes a "Di" sound and starts 20 seconds countdown, LCD screen displaying:

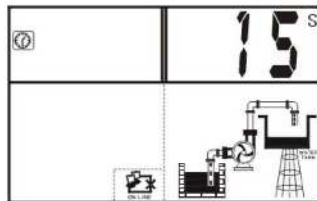

- Pump stops running and parameter calibration completed, LCD screen displaying:  
M21 is ready for running.

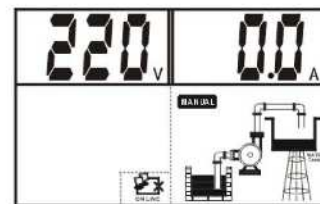

### Erasing former parameter calibration

When pump is reinstalled after maintenance or new pump is installed, user must erase the former parameter calibration and a new calibration must be done.

### Erasing the parameter calibration

- Press the **MODE** key to switch to manual state, make sure the pump not running and LCD screen displaying:

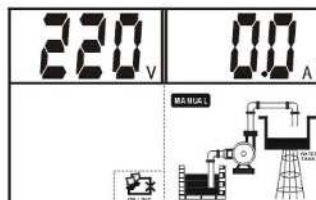

- Press the **STOP** key and release till M21 makes a "Di" sound, M21 recover the default factory setting and LCD screen displaying:

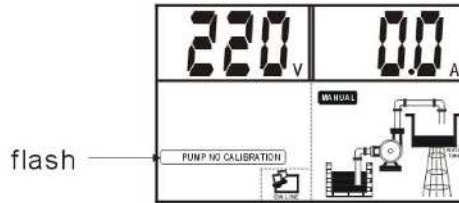

### 3 ELECTRICAL CONNECTION

#### 3.1 Installing liquid probe & float switch

##### Liquid probe installation

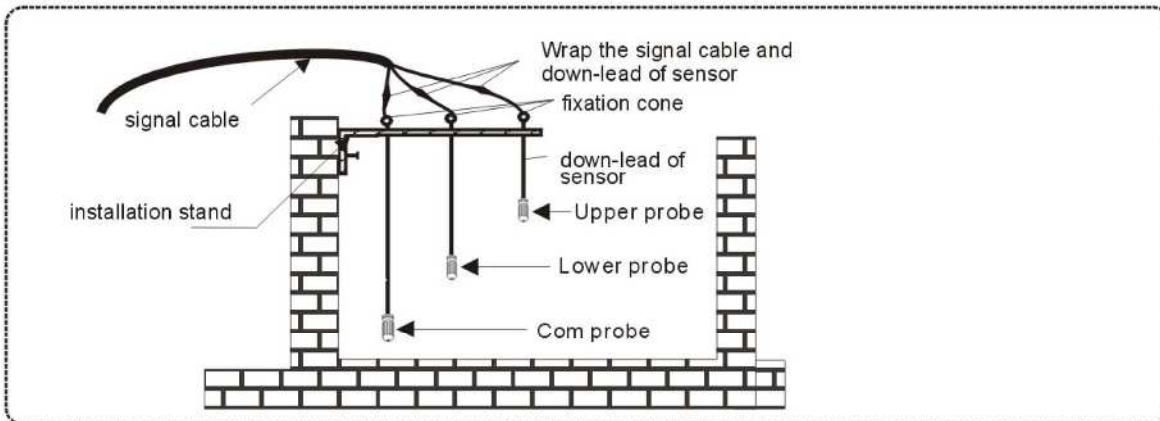

- ⚠ In event of high risk of electric storms (lightning) or when liquid medium in well or tank or sump is very dirty it is recommended float switch is used.

##### Float switch installation

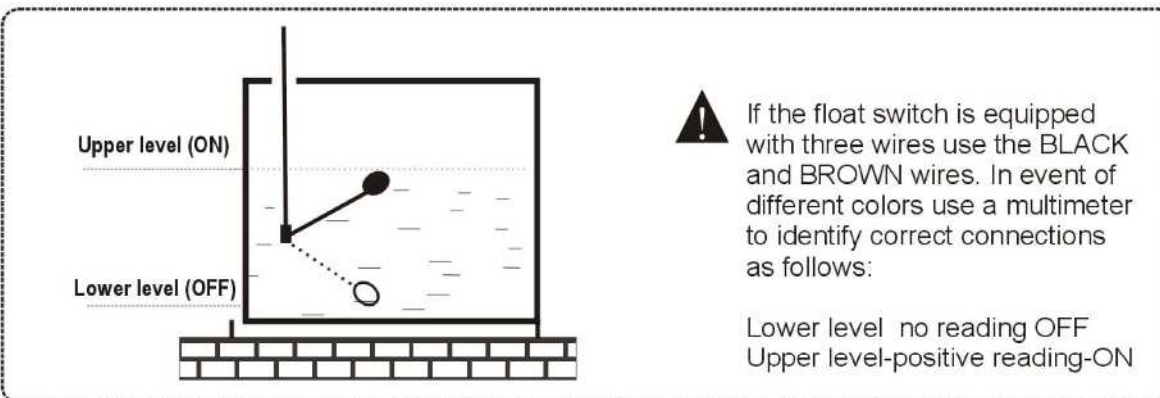

- ⚠ DO NOT ENCASE SENSOR LEADS, FLOAT SWITCH WIRE OR SIGNAL CABLES IN METAL PIPES. USE PVC OR PE TUBING.

### 3.2 Electrical connection for different application

#### 3.2.1 Water supply by liquid level control through float switch or liquid probe

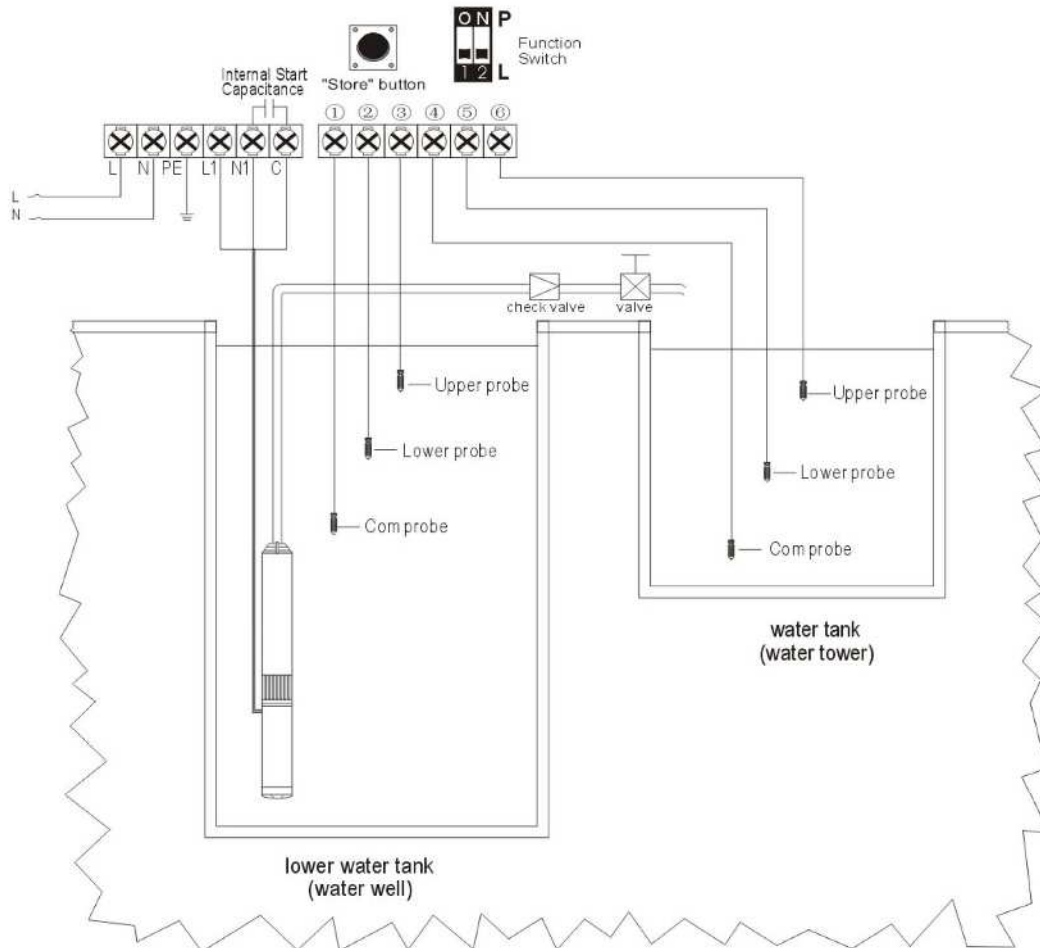
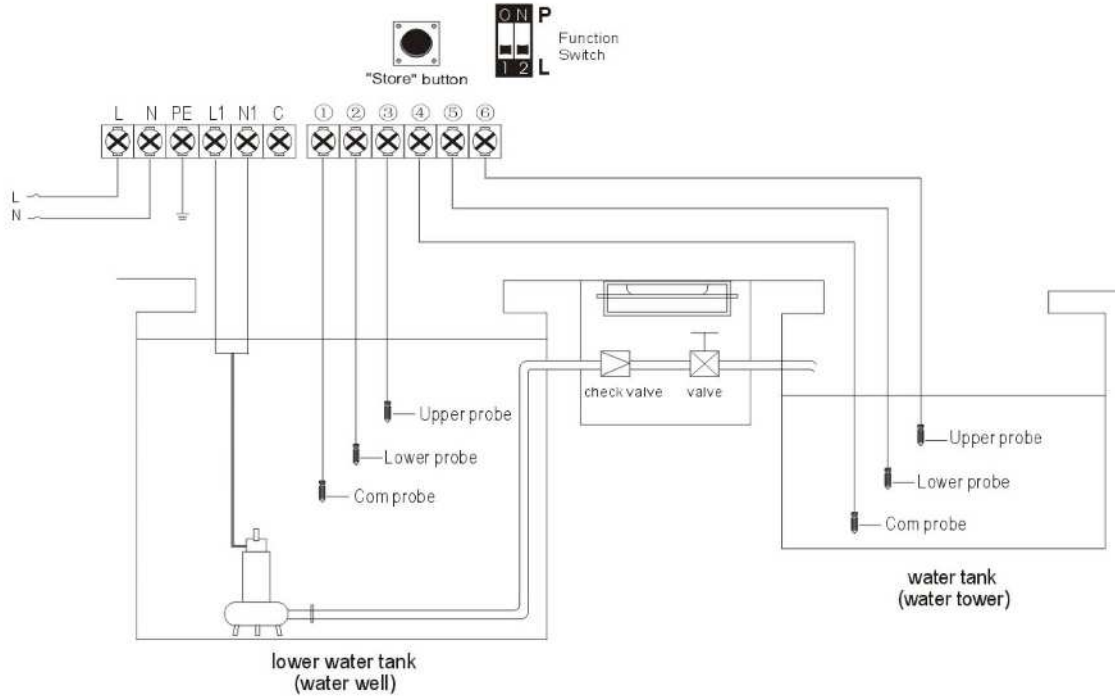

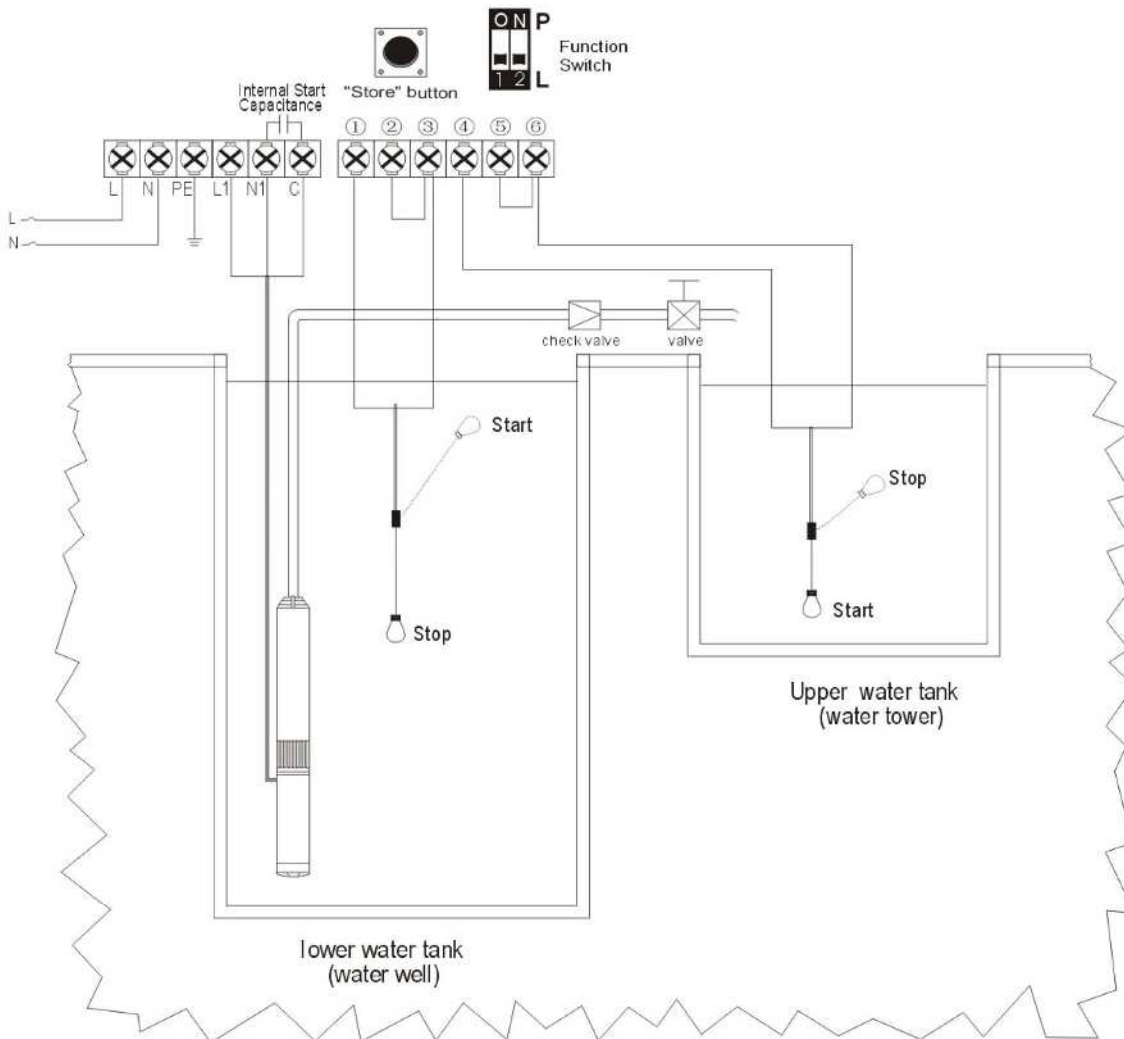
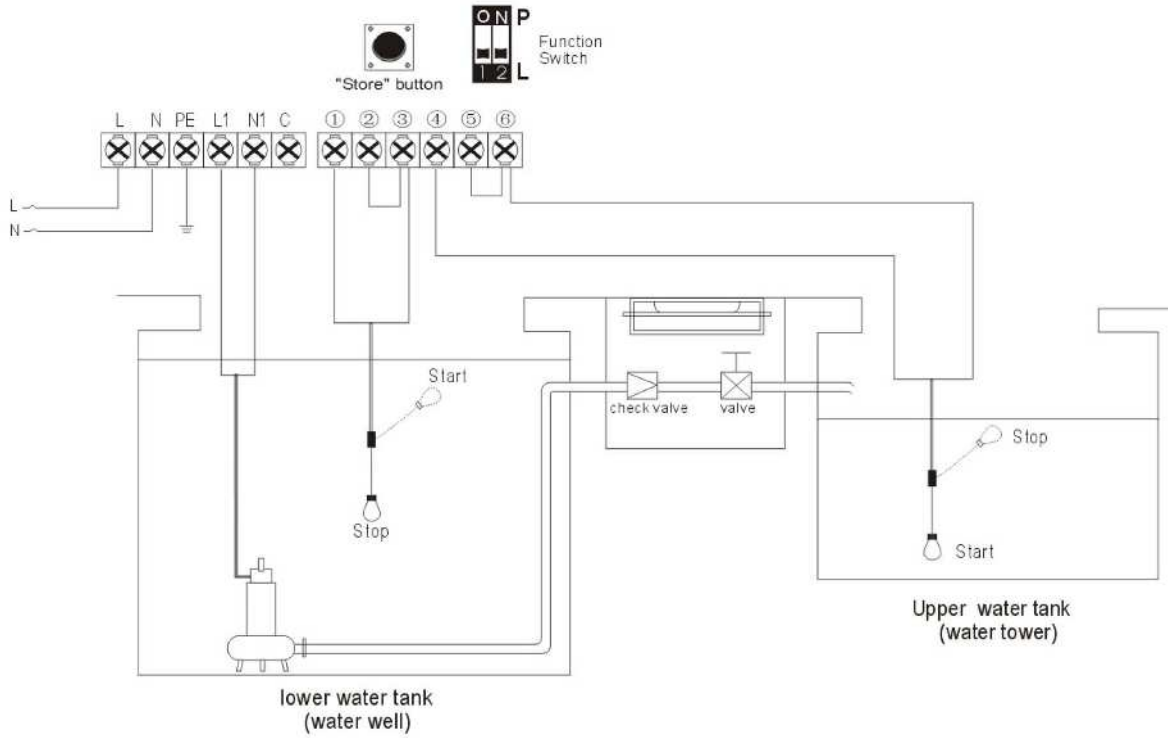

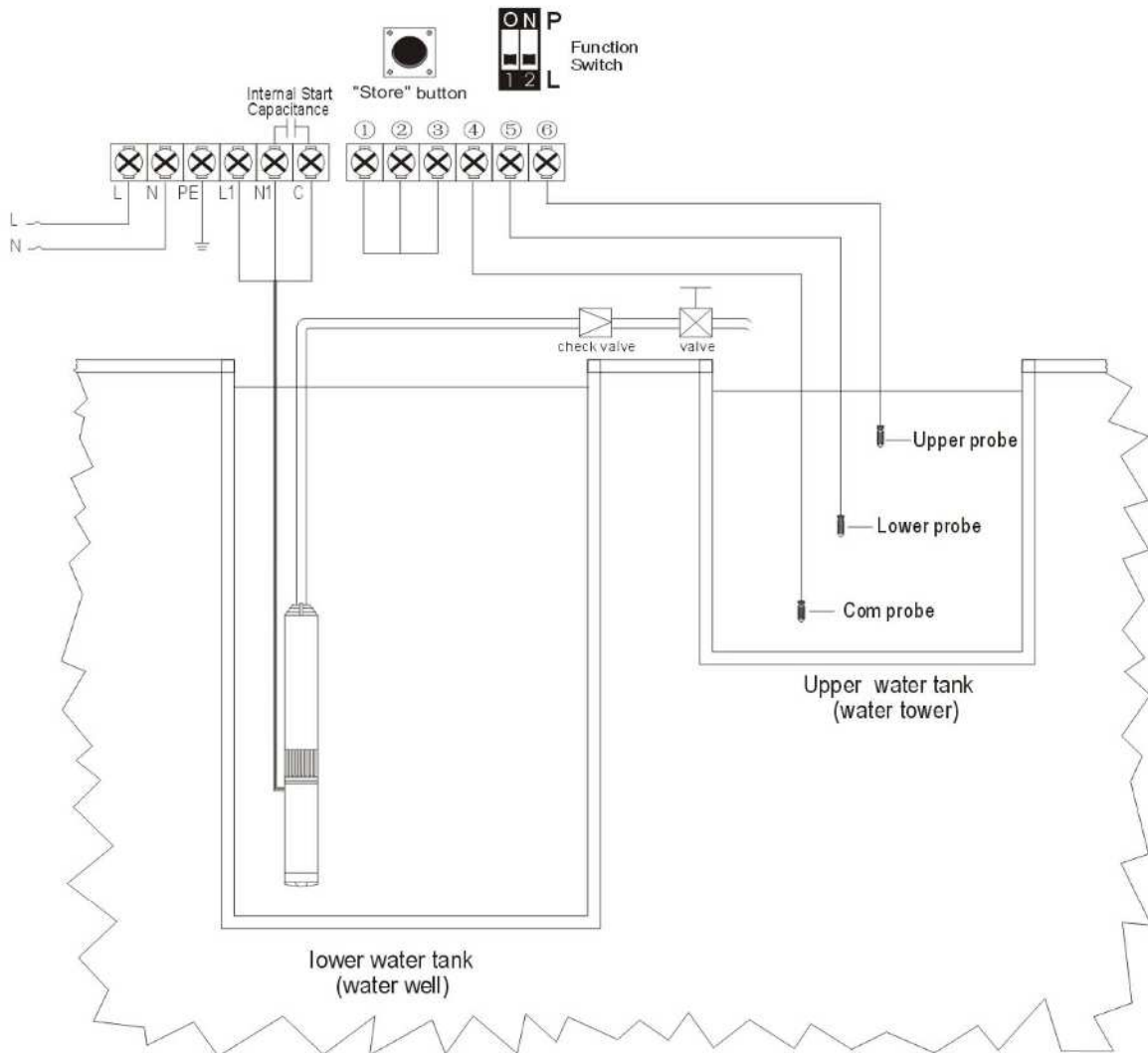
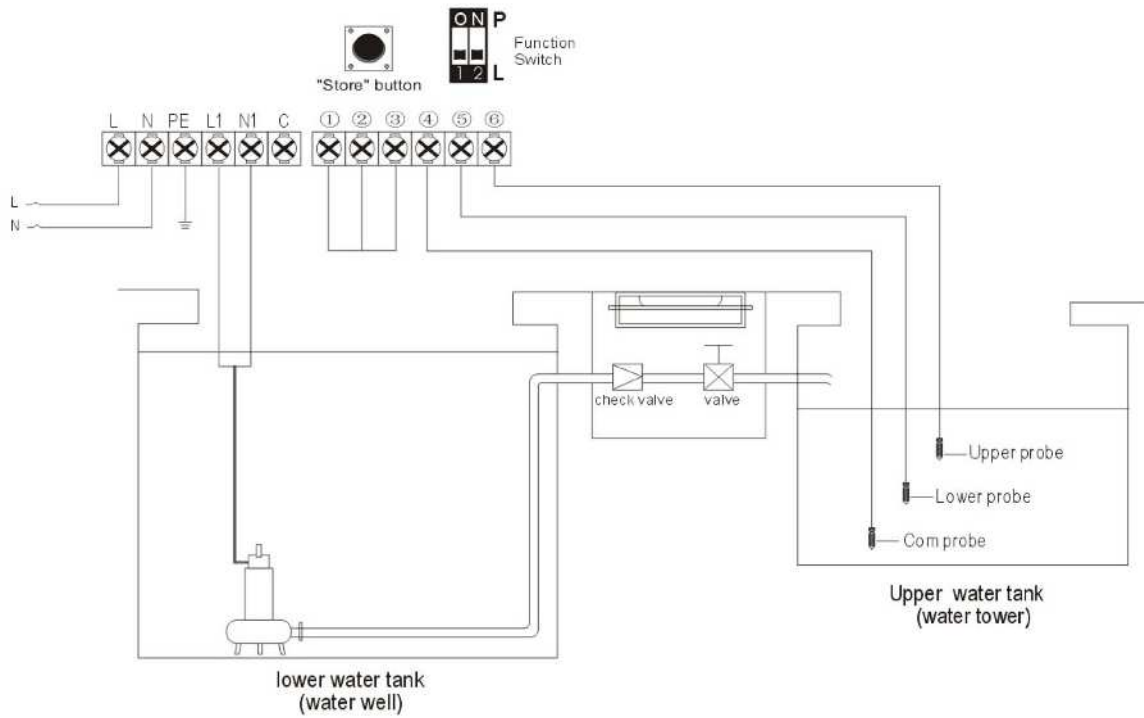

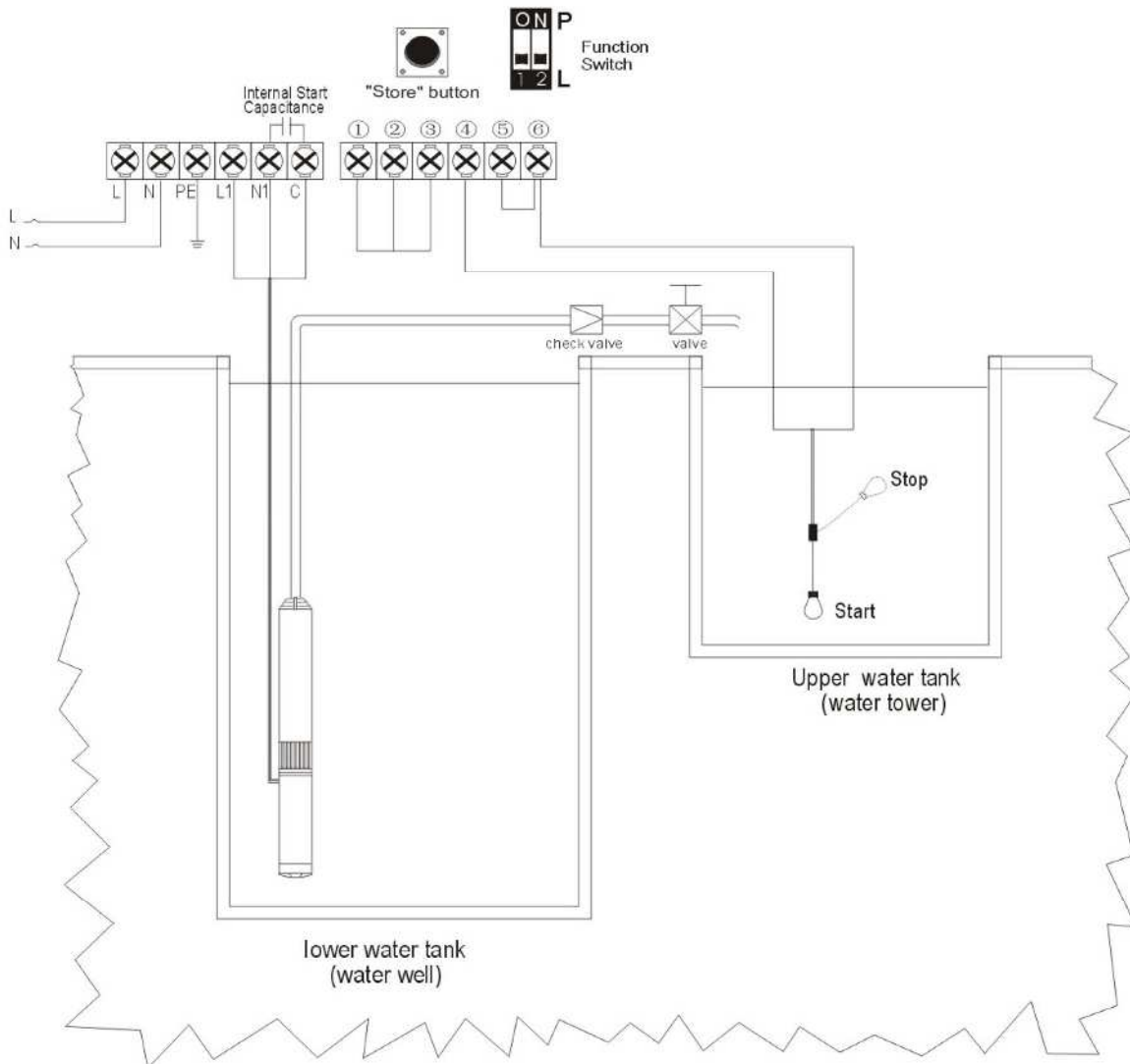
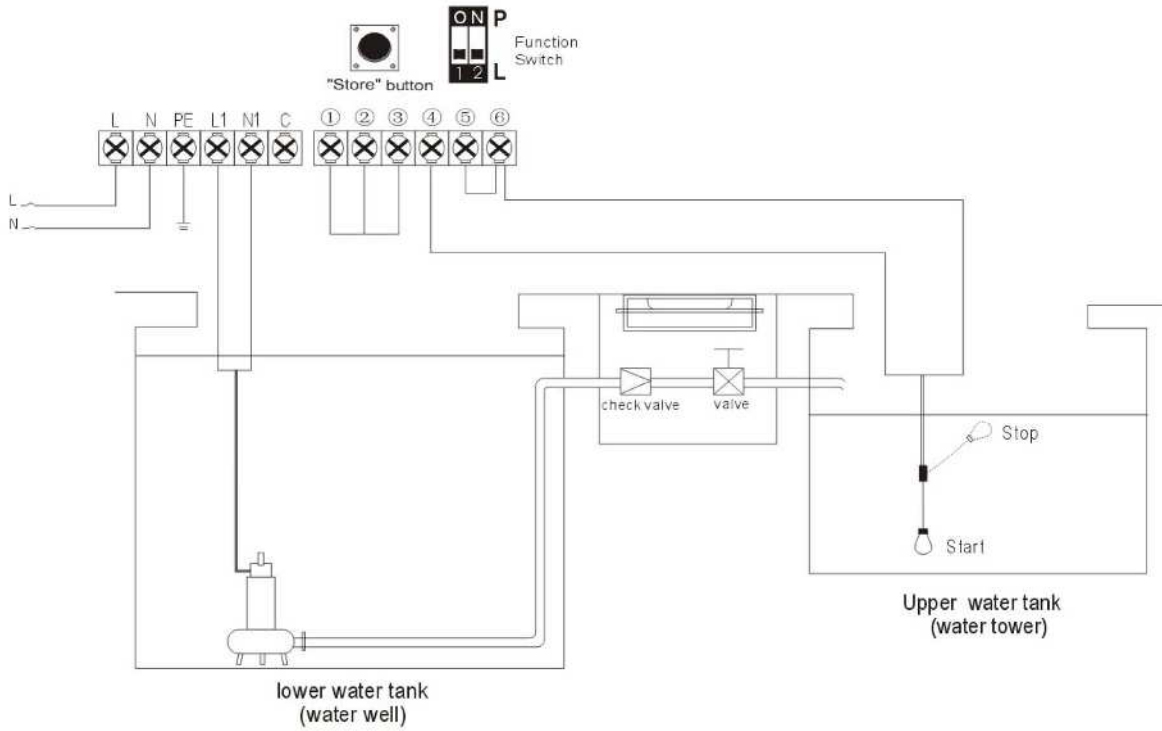

**1). Starting condition**

liquid level in the water tank is below Lower probe (float switch: Down level) and liquid level in the water well is above Lower probe (float switch: Up level), the M21 will run pump;

**2). Stop condition**

liquid level in the water tank reaches Upper probe (float switch: Up level) or liquid level in the water well is below Lower probe (float switch: Down level); the M21 will stop pump running;

**3). The probe / sensor free in the water well**

as the M21 has reliable and automatic stop function against pump dry-run (dewatering), if it is used in submersible pump for deep well, pipeline pump or other situations when it is inconvenient to install lower liquid probe in the well, pump users can put terminals ①、②、③ in short circuit, which minimize the troubles and costs.

**4). Meaning of the messages & graphic shown on the LCD screen**

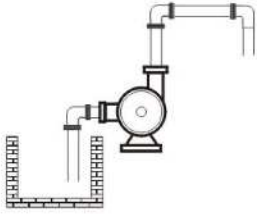
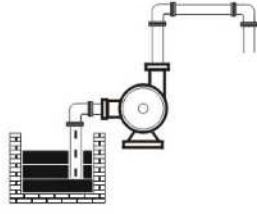
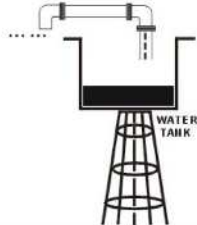
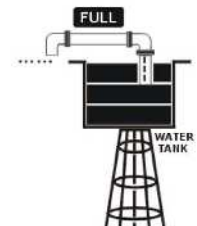
Messages & Graphic	Description
	Lack of water in water well
	Full of water in water well
	Lack of water in water tank
	Full of water in water tank



**3.2.2 Water supply by pressure control through pressure switch & pressure tank**

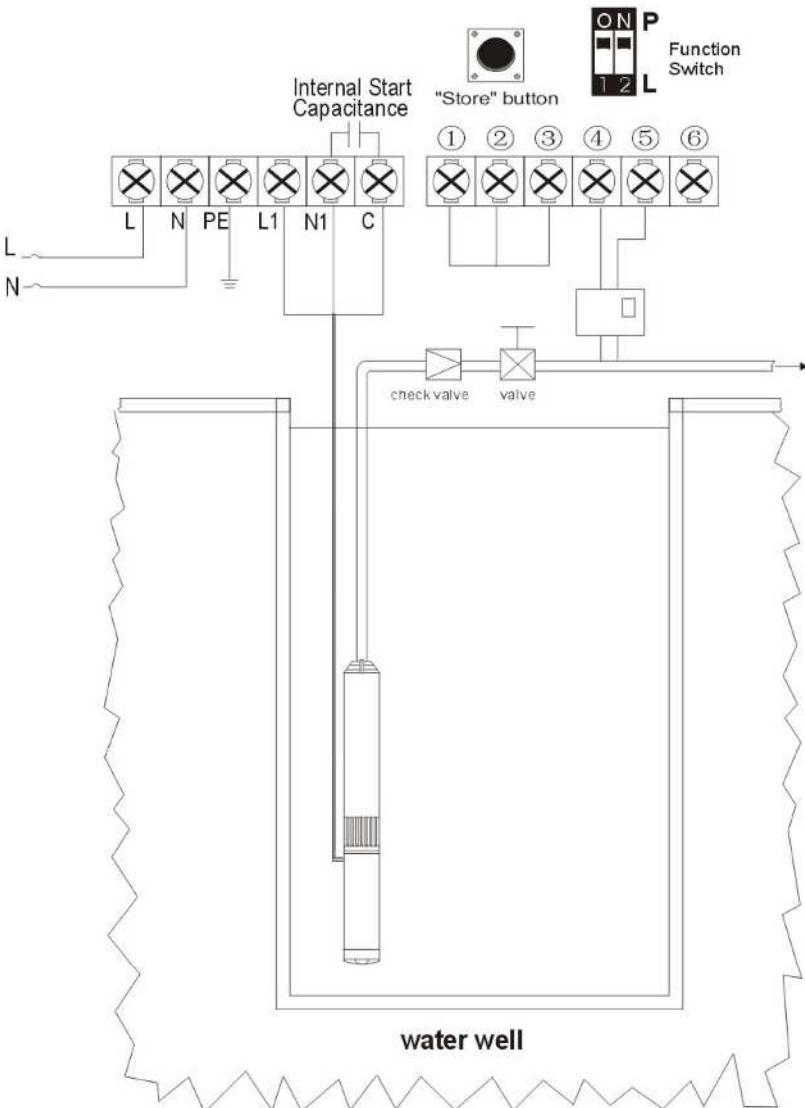
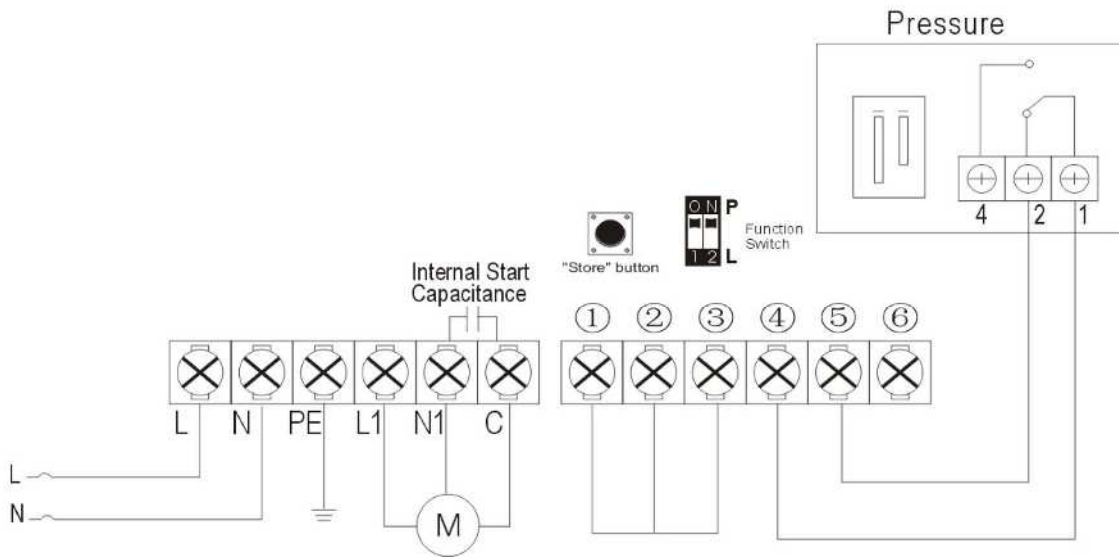

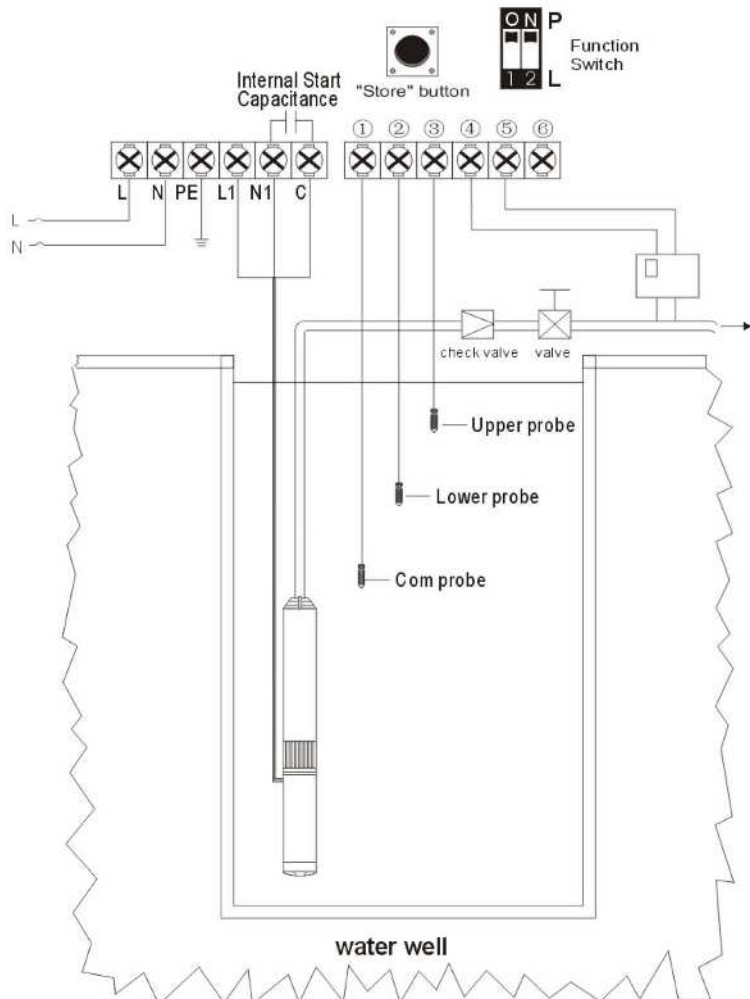
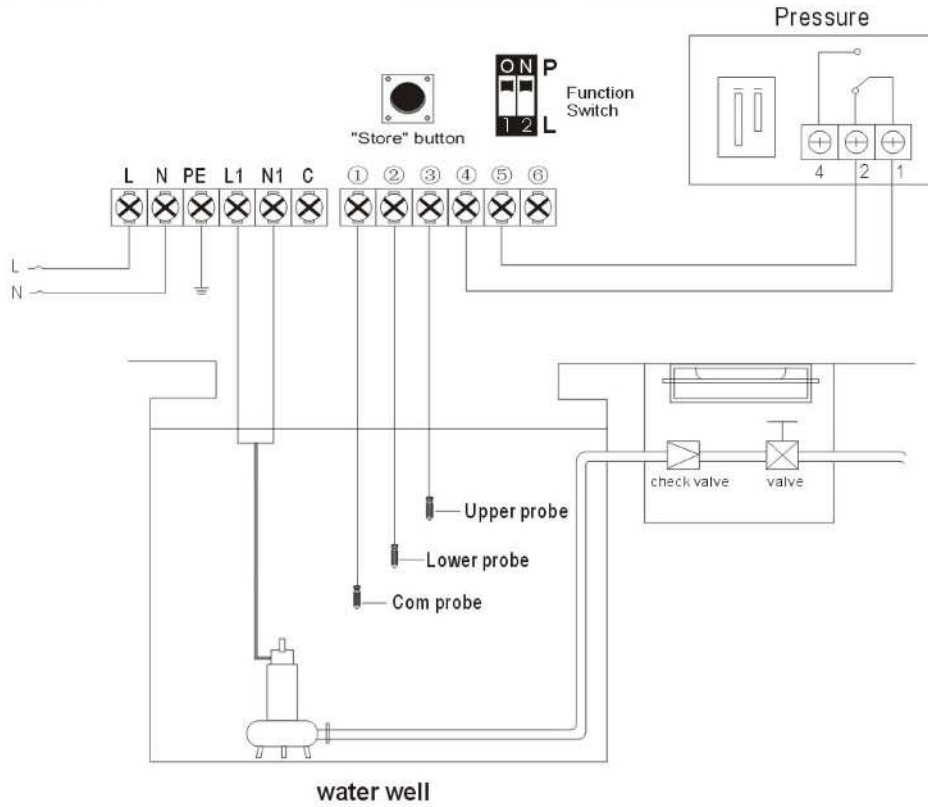

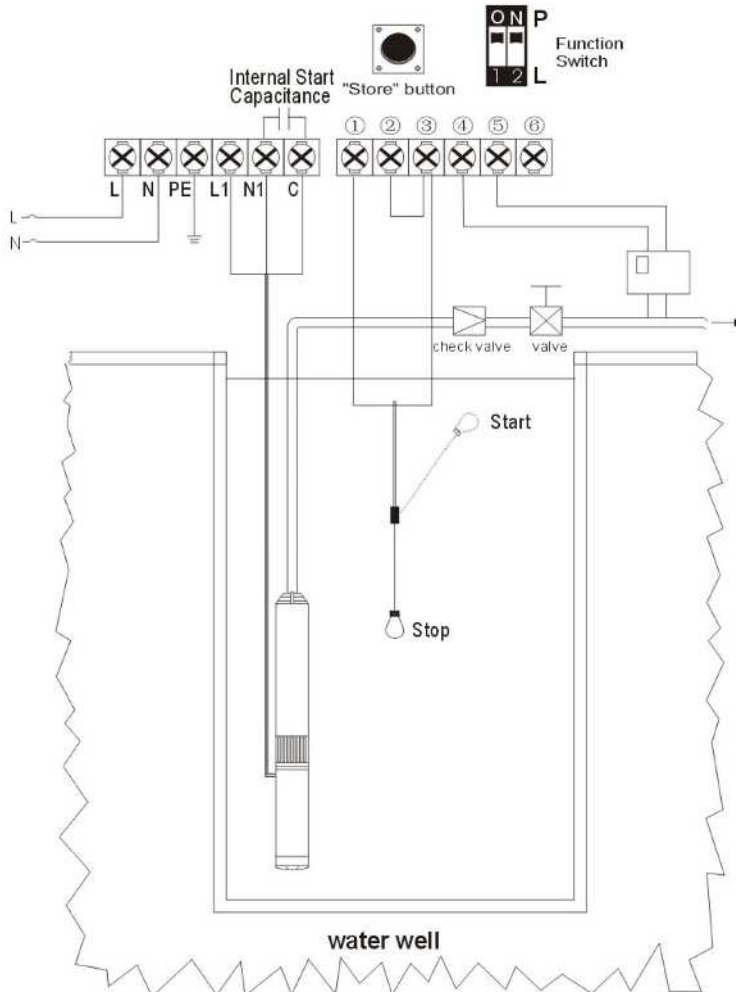
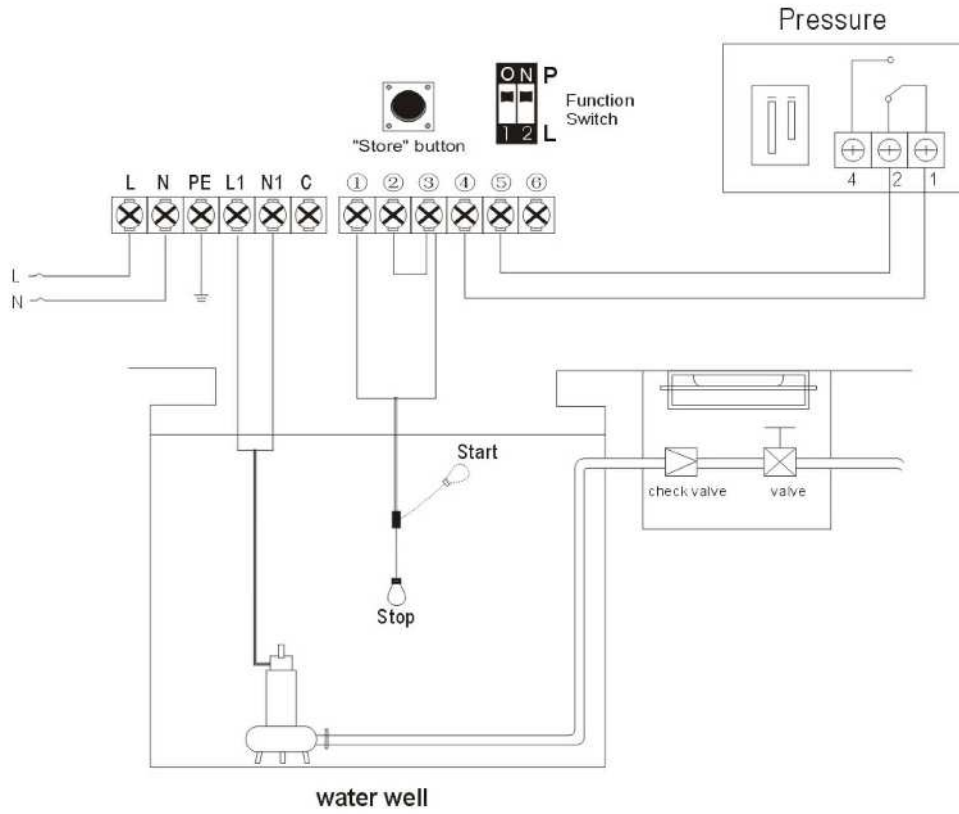

**1). Starting condition**

there is no pressure in the pipeline or pressure tank, contacting point of pressure switch is ON and liquid level in the water well is above Lower probe (float switch: Up level), the M21 will run pump;

**2). Stop condition**

there is full pressure in the pipeline or pressure tank, contacting point of pressure switch is OFF, the M21 will stop pump running;



**Note:** pressure switch with N/C (normal close) contacting point:

no pressure, contacting point is ON; meet the pressure setting, contacting point is OFF

**3). The probe / sensor free in the water well**

as the M21 has reliable and automatic stop function against pump dry-run (dewatering), if it is used in submersible pump for deep well, pipeline pump or other situations when it is inconvenient to install lower liquid probe in the well, pump users can put terminals ①、②、③ in short circuit, which minimize the troubles and costs.

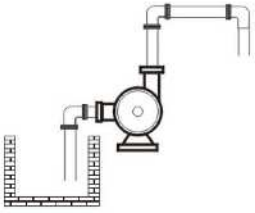
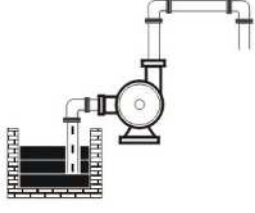
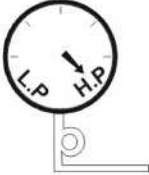
**4). Meaning of the messages & graphic shown on the LCD screen**

Messages & Graphic	Description
	Lack of water in water well
	Full of water in water well
	Full of pressure in pipeline or pressure tank
	Lack of pressure in pipeline or pressure tank

**3.2.3 Drainage by liquid level control through float switch & liquid probe**

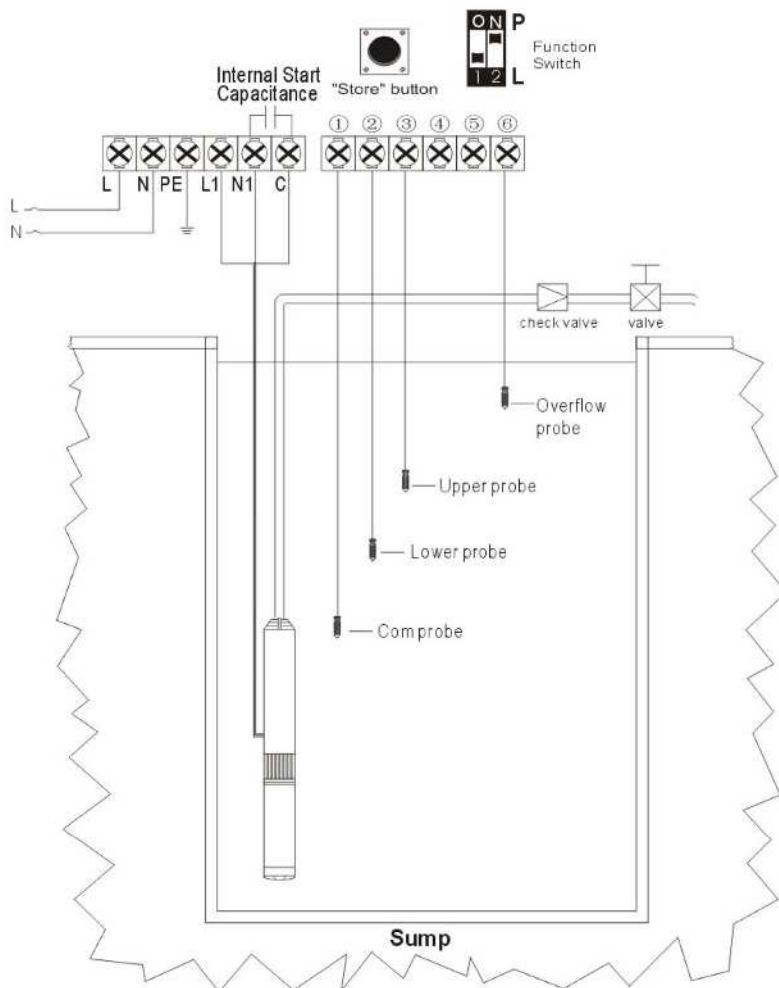
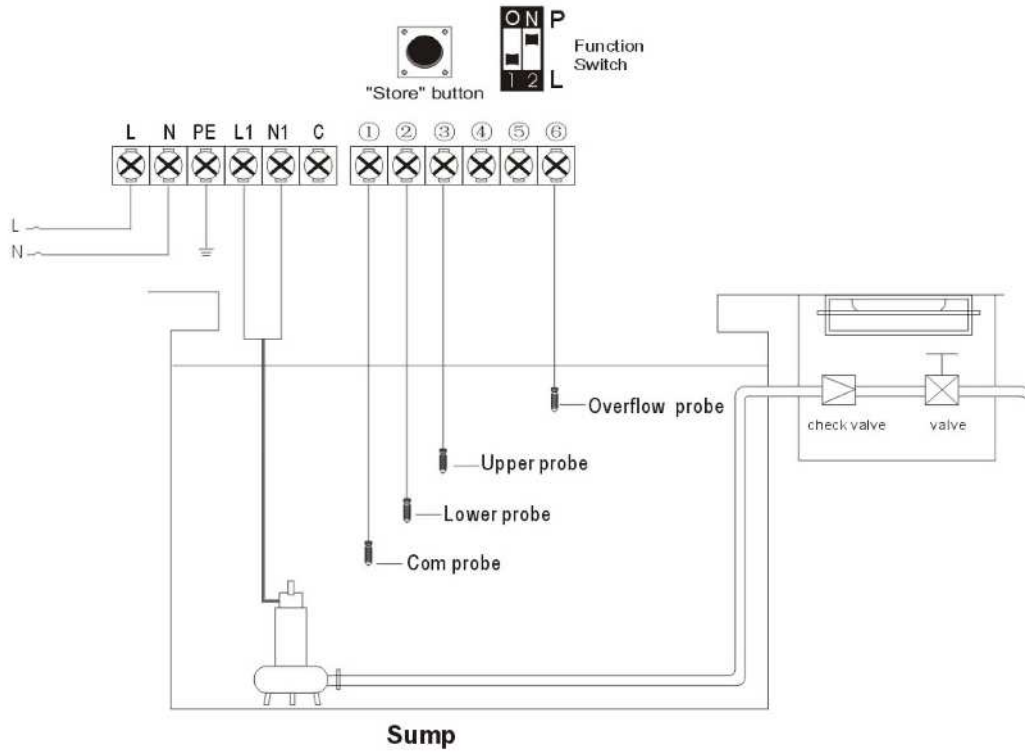

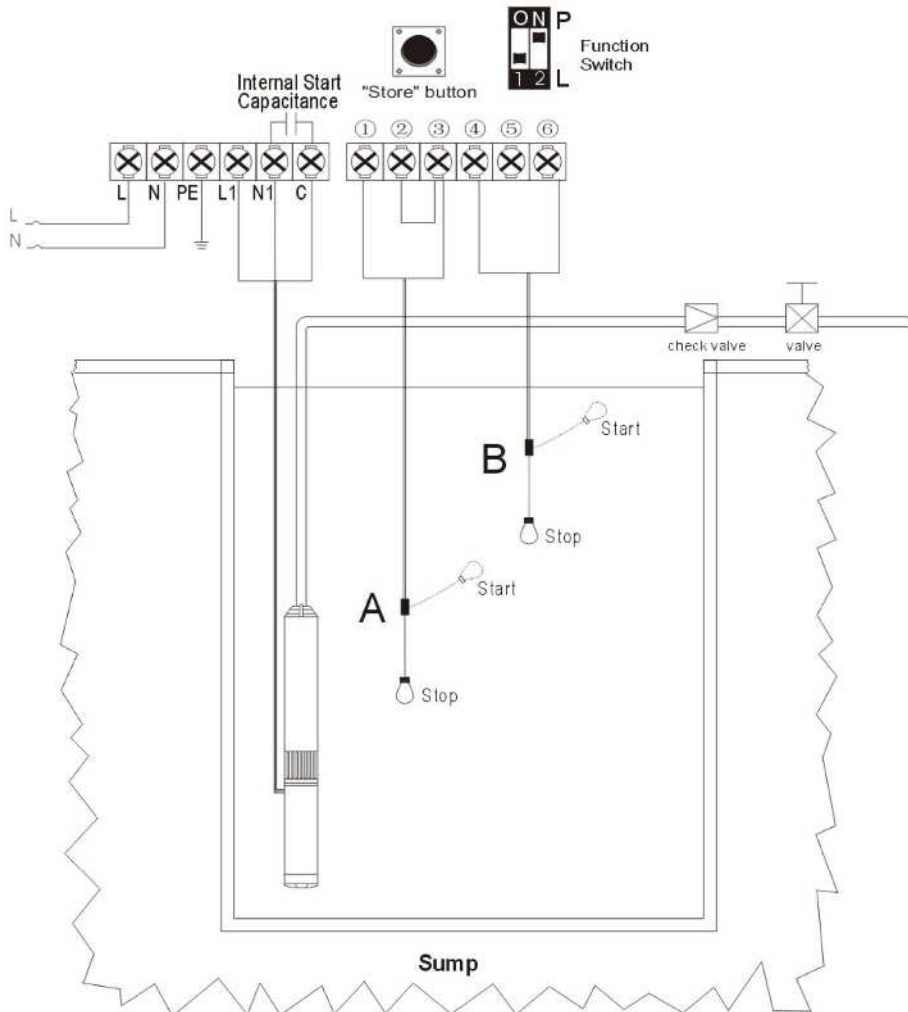
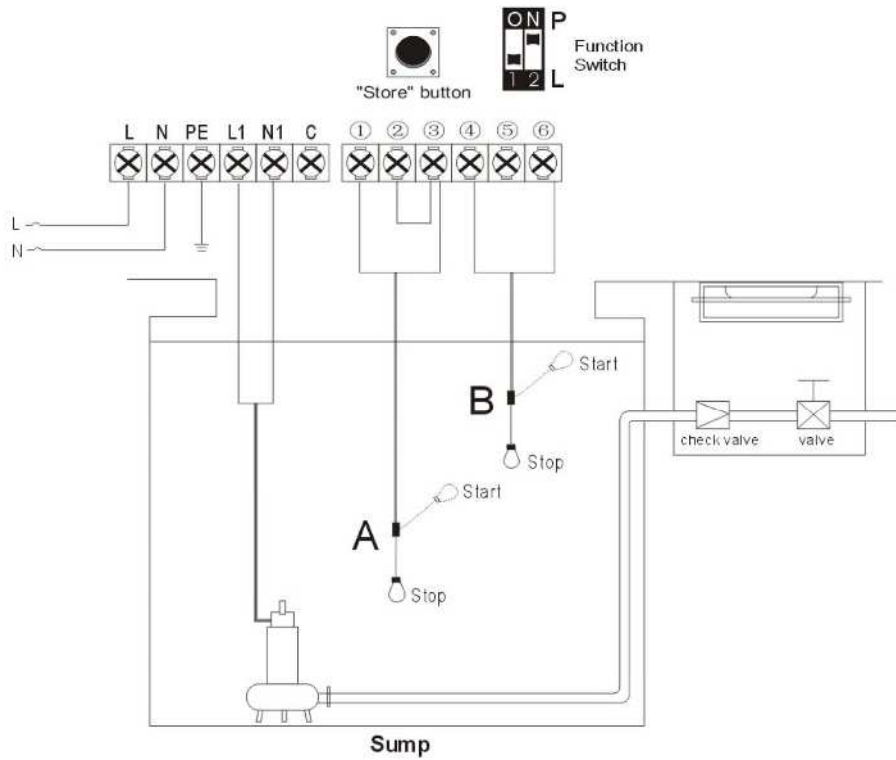

**1). Starting condition**

liquid level in the sump reaches Upper probe (float switch A: Up level), the M21 will run pump;

**2). Stop condition**

liquid level in the sump is below Lower probe (float switch A: Down level), the M21 will stop pump running;

**3). Over Flow alarm**

when pump is draining water, liquid level in the sump is still rising to Overflow probe (float switch B: Up level), the M21 will sound the overflow alarm to warn pump user to take further action.

**4). Meaning of the messages & graphic shown on the LCD screen**

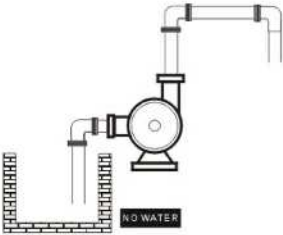
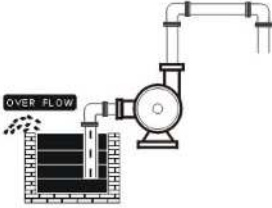
Messages & Graphic	Description
	Lack of water in sump
	Overflow in sump

## 4 BASIC OPERATION

### 4.1 Switching to MANULA mode

Press the **MODE** key to switch to manual state, M21 is under the manual control state; under manual state, press the **START** key to run pump; press the **STOP** key to stop pump running;

**Note:** under manual state, the M21 can not receive the signal from liquid level probe or pressure switch.

### 4.2 Switching to AUTO mode

Press the **MODE** key to switch to auto state, M21 is under the auto control state; under auto state, M21 will run or stop the pump according to the signal from liquid level probe or pressure switch.

**Note:** under auto state, if the pump is running and pump user wants to stop pump running compulsory, press the **MODE** key to switch to manual state and pump stops running;

**Note:** under auto state, if the input power being cut off and recovery power again, the M21 will enter operation state after 10seconds countdown;

**Note:** no matter the M21 is under auto or manual state, if the input power being cut off and recovery power again, the M21 will resume its operation state as the operation state before power being cut off;

### 4.3 Pump protection

During pump running, if dry run, over load, under voltage, over voltage etc failures happened, the M21 will immediately shut down the pump running and automatically execute a check for restarting conditions after a built in time delay has elapsed. The M21 will not recover automatically until all the abnormal situation(s) have been cleared.

If pump stalled, open phase etc serious failures happened, pump user must check the pump and motor immediately and repair the pump.

### 4.4 Pump last five failure record displaying

The M21 can memorize the last five failures of pump, so it is very convenient for the pump users to analyse the pump running conditions.

#### Displaying the pump last five failure record

- Press the **MODE** key to switch to manual state, make sure the pump not running and LCD screen displaying:

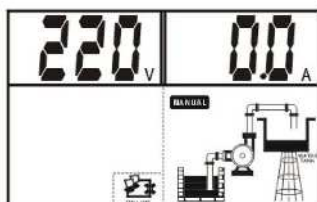



- Hold pressing **STOP** key and press **MODE** key, the M21 makes a "Di" sound, the M21 displays pump failure record;
- Press **STOP** key to quit the failure record displaying;

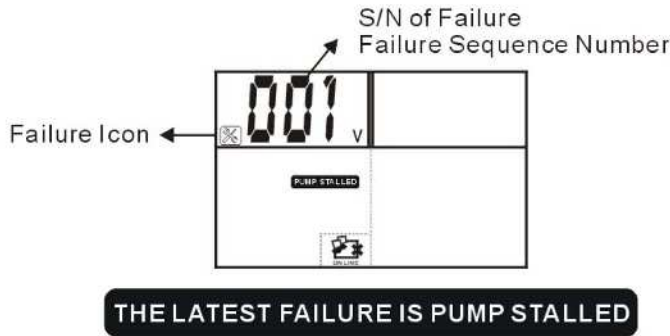

#### 4.5 Pump accumulative running time displaying

The M21 can memorize how many hours of pump running, so it is very convenient for the pump users to analyse the pump running conditions and do maintenance

##### Displaying the pump accumulative running time

- Press the **MODE** key to switch to manual state, make sure the pump not running and LCD screen displaying:

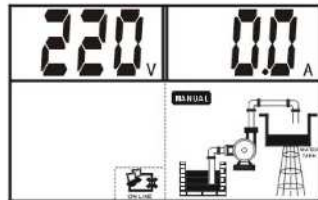

- Hold pressing **STORE** button and press **STOP** key, the M21 makes a "Di" sound, the M21 displays pump failure record;

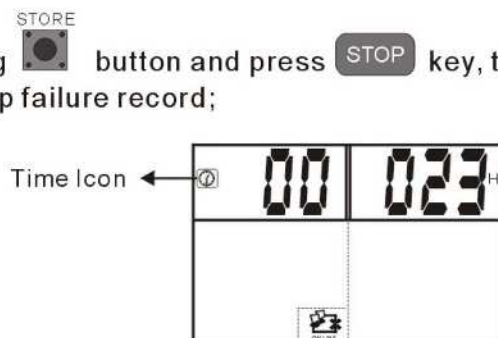

- Press **STOP** key to quit the accumulative running time displaying;

### 5 COMMUNICATION LINK

Model M21 has communication interface, To adopting simple peripheral equipment (Slave Controller), pump users can realize long distance monitoring function.

This function is applied for M21 installed in the basement, pumping room etc, but pump users require to monitor and control the pump on the ground or in the control room.

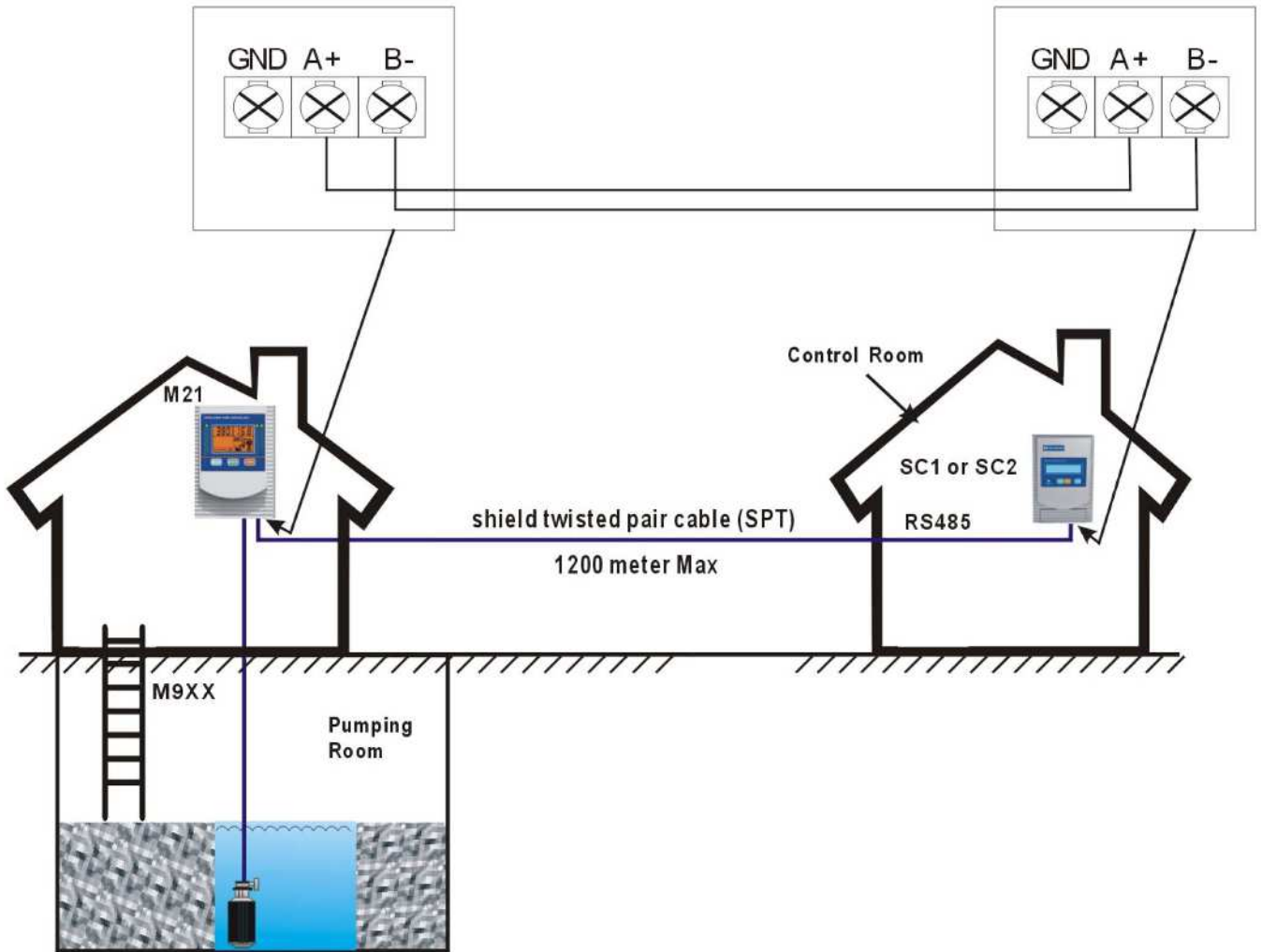

## 5.1 Basic Function

Slave Controller, model SC1 with communication interface can realize long distance monitoring function. In the control room, pump users can realize all functions of M21 (Master Controller) through SC1, including:

voltage & ampere displaying, pump fault displaying, auto / manual switch, pump start/ stop switch, pump running status displaying etc

## 5.2 Special Application

As adopting communication interface, the wire communication distance is less than 1200metres. For those installation environment which require long distance communication, say: mine, water tower, across railway, road and bridge etc, users can adopt RS485 extender, wireless communication or GSM system.

Please contact the manufacturer for more information.

## 5.3 Technical parameter

The following chart shows main technical parameters of communication link between M21 & Slave Controller (SC)

The following chart shows main technical parameters of communication link between M21 & Slave Controller (SC)

<b>Main technical data</b>	
Physics Interface	RS485 Bus Interface: asynchronism semiduplex
Data format	1start bit 8data bit, 1stop bit, no verify 1start bit 8data bit, 2stop bit, no verify Default: 1start bit 8data bit, 1stop bit, no verify
Baud rate	1200 bps、2400 bps、4800 bps、9600bps <b>Default: 9600bps</b>
Communication address	Setting range of controller address: 1-126 127: broadcast address, Host computer broadcasting, Slave machine responson forbidden
Protocol type	MODBUS Protocol (RTU)
Rated input voltage for SC	AC220V/50Hz, Single phase
<b>Main installation data</b>	
wire communication distance	1200meters max by shield twisted pair cable (STP) for RS485 & CAN 5000meters max by STP and RS485 extender
STP	STP-120Ω one pair 20AWG for RS485 & CAN
RS485 extender	5000meters (9600bps)

## 6 TROUBLE SHOOTING GUIDE

Fault Message	Possible Cause	Solutions
flashing of <b>UNDER V</b>	the real running voltage is lower than the calibrated voltage, pump is in under voltage protection state	report low line voltage to the power supply company
		M21 will attempt to restart the pump every 5minutes until line voltage is restored to normal
flashing of <b>OVER V</b>	the real running voltage is higher than the calibrated voltage, pump is in over voltage protection state	report high line voltage to the power supply company
		M21 will attempt to restart the pump every 5minutes until line voltage is restored to normal
flashing of <b>OVER LOAD</b>	the real running ampere is higher than the calibrated running ampere, pump is in over load protection state	M21 will attempt to restart the pump every 30minutes until running ampere is restored to normal
	pump impeller is jammed / pump motor dragging / pump bearing broken	check pump impeller or bearing
flashing of <b>PUMP NO CALIBRATION</b>	parameter calibration not completed	refer to parameter calibration setting
flashing of <b>DRY RUN</b>	liquid level in the well / sump is below the pump intake, pump stops running	M21 will attempt to restart the pump every 30minutes until liquid level above the pump intake
flashing of <b>PUMP STALLED</b>	pump motor running ampere increasing was greater than the normal running ampere (calibrated ampere) by more than 200%	cut off power supply & repair or replace pump immediately
 <b>ON LINE</b>	no communication link between SC / computer and M21	connecting the M21 to SC / computer to realize long distance monitoring